

**CAPTURE® P15, Q20, D20, CQ, CD G2
Motion Detectors**

INS878EN-4

15-07-2021	<ul style="list-style-type: none">• Manual created• PCR01491 - Changes made to ceiling walk test diagrams• Changed D15 to D20 throughout Changed coverage diagram for D20 (but not PET) <ul style="list-style-type: none">• Changed Pet mode coverage and updated all drawings to reference D20 instead of D15• Changes made in relation to PCR01383• Updated pet coverage drawings to 10m• PCR01383 Updated coverage patterns following comments from Kiwa certification engineers.• PCR01383 updated pet drawings and reference to pet compliance.• Changes screws and screw descriptions for brackets
------------	-----------------------------------------------------------------------------------------------------------------------------------------------------------------------------------------------------------------------------------------------------------------------------------------------------------------------------------------------------------------------------------------------------------------------------------------------------------------------------------------------------------------------------------------------------------------------------------------------------------------------------------------------------------------------------------------------------

Content

- 1.0 Quick installation** 4
 - 1.1 Opening the device 4
 - 1.2 Mounting and cable entry 8
 - 1.3 Wiring and EOL selection 18
 - 1.4 Mode selection 23
 - 1.5 Testing, commissioning & LED indications 29
- 2.0 Variants** 31
 - 2.1 CAPTURE P15 31
 - 2.2 CAPTURE Q20 37
 - 2.3 CAPTURE D20 43
 - 2.4 CAPTURE CQ 51
 - 2.5 CAPTURE CD 54
- 3.0 Accessories** 58
 - 3.1 Branding 59
 - 3.2 Optional wall or ceiling mount brackets 63
- 4.0 Specifications** 68
- 5.0 Legal information** 69
 - 5.1 Supplier 69
 - 5.2 WEEE Directive 69
 - 5.3 Maintenance 70
 - 5.4 Warranty 70

1.0 Quick installation

1.1 Opening the device

The devices are supplied in the unlocked position. If locked.

- Use a flat bladed terminal driver and turn the locking mechanism $\frac{1}{4}$ turn anti-clockwise.
- Slide the front down and towards you to remove.
- For ceiling mount devices remove the facia by turning it anti-clockwise, and then unlock as above.

Locking Mechanism

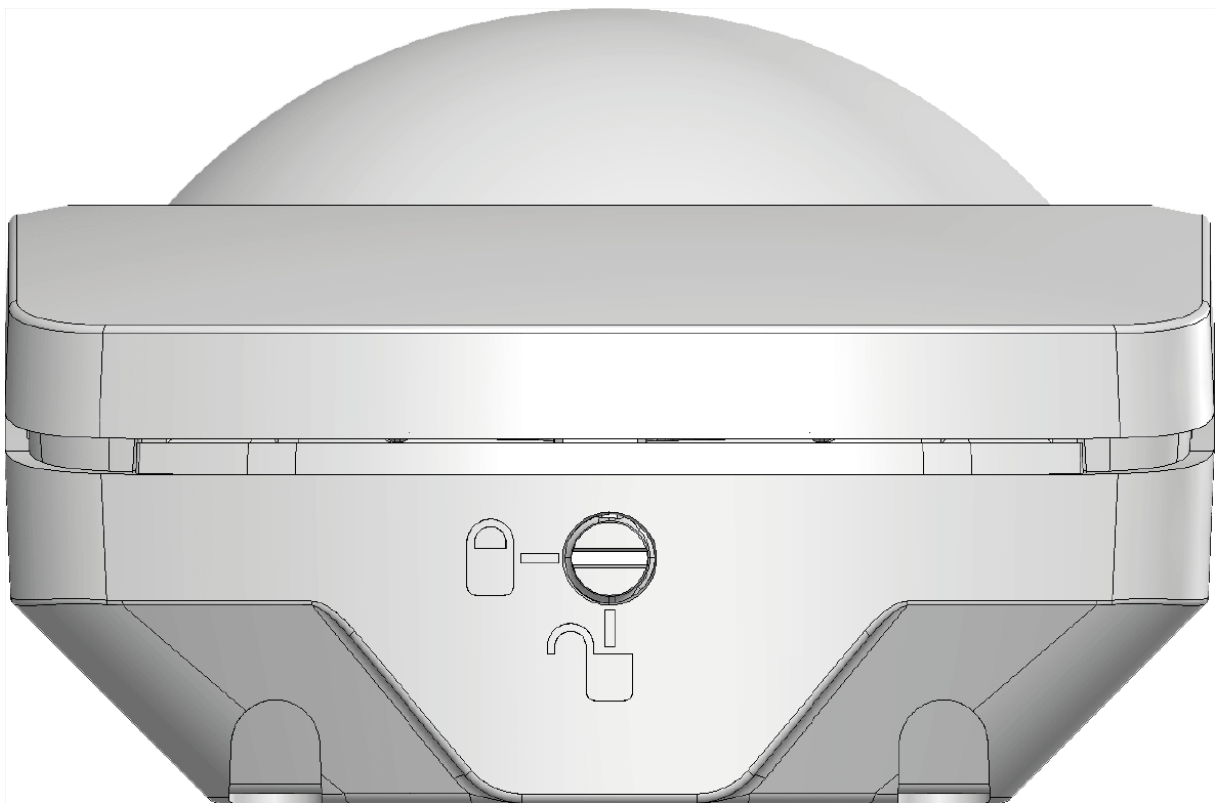

Opening the device

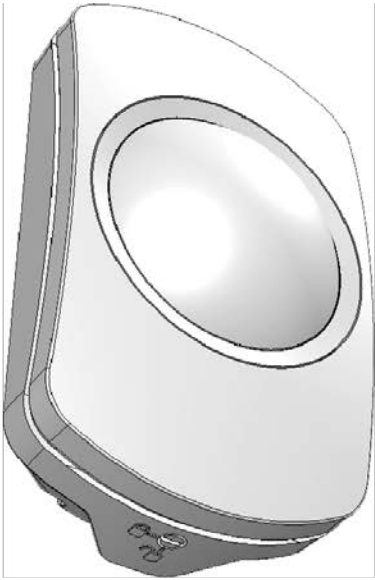

2

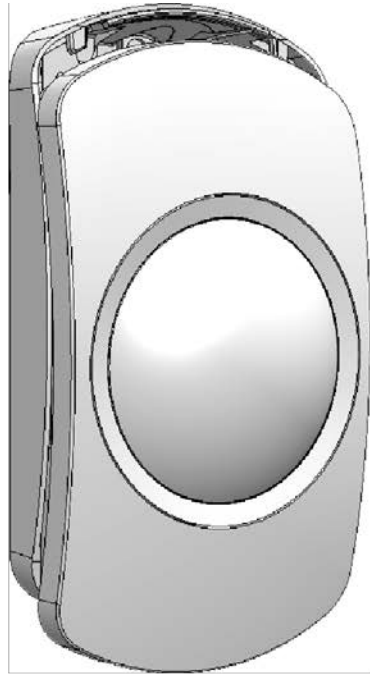

3

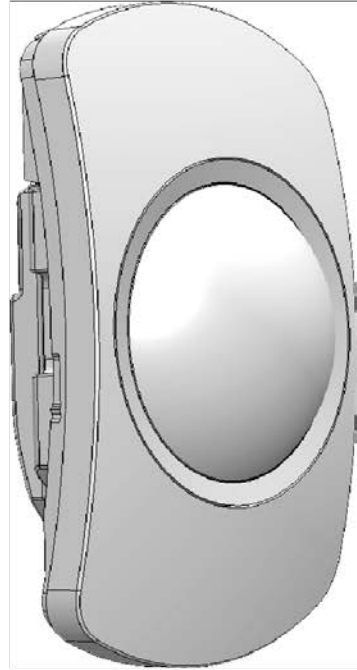
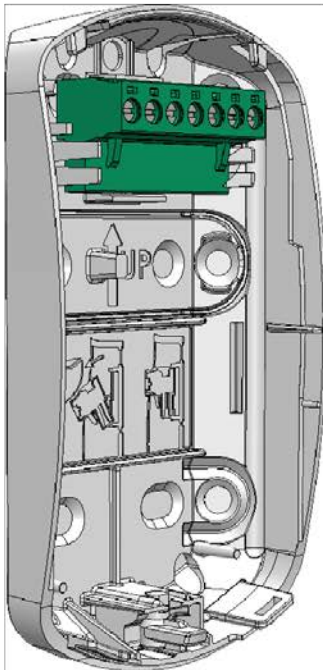

Ceiling facia removal

1 

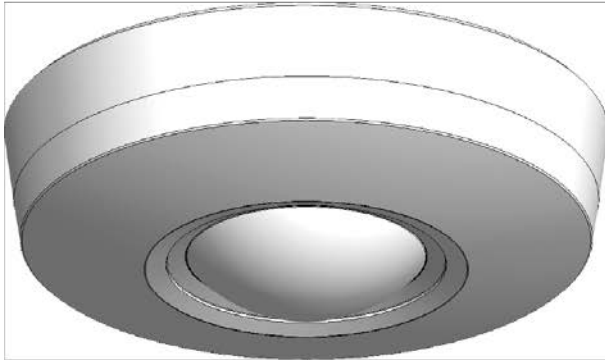

2 

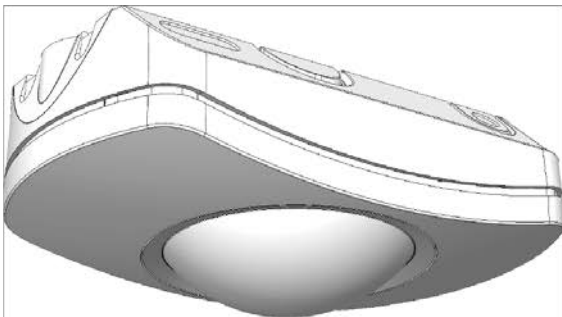
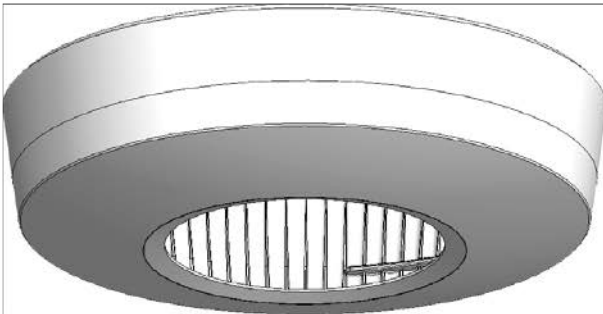

1.2 Mounting and cable entry

Location

Ensure you have the correct device for the intended application, and that it is sited correctly in the desired location. The field of view should be free from obstacles and any potential false alert causes.

Devices should be mounted on stable internal surfaces and are **NOT** suitable for use externally.

Avoid common false alert causes

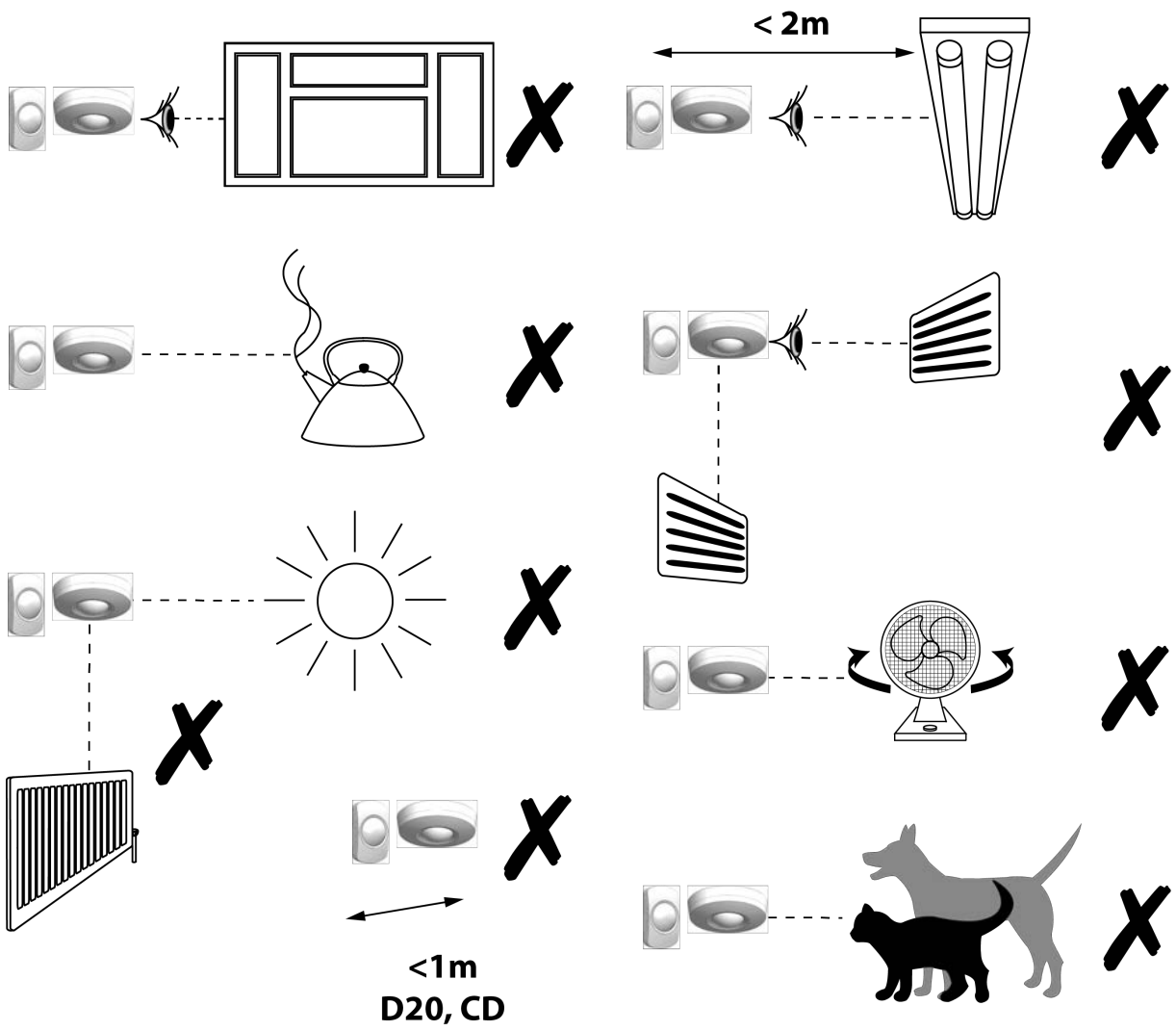

CQ, CD Only

Ensure the devices field of view is not obstructed



Install on a flat stable surface only

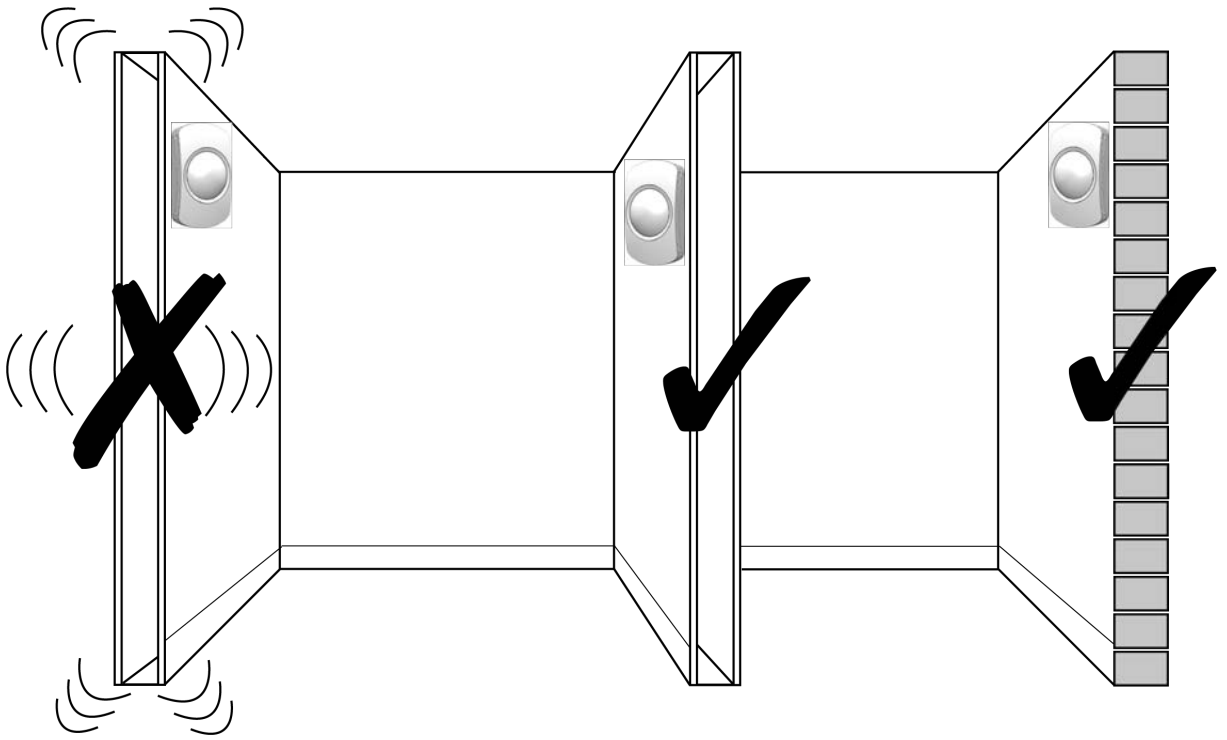

Ensure surrounding structures are stable

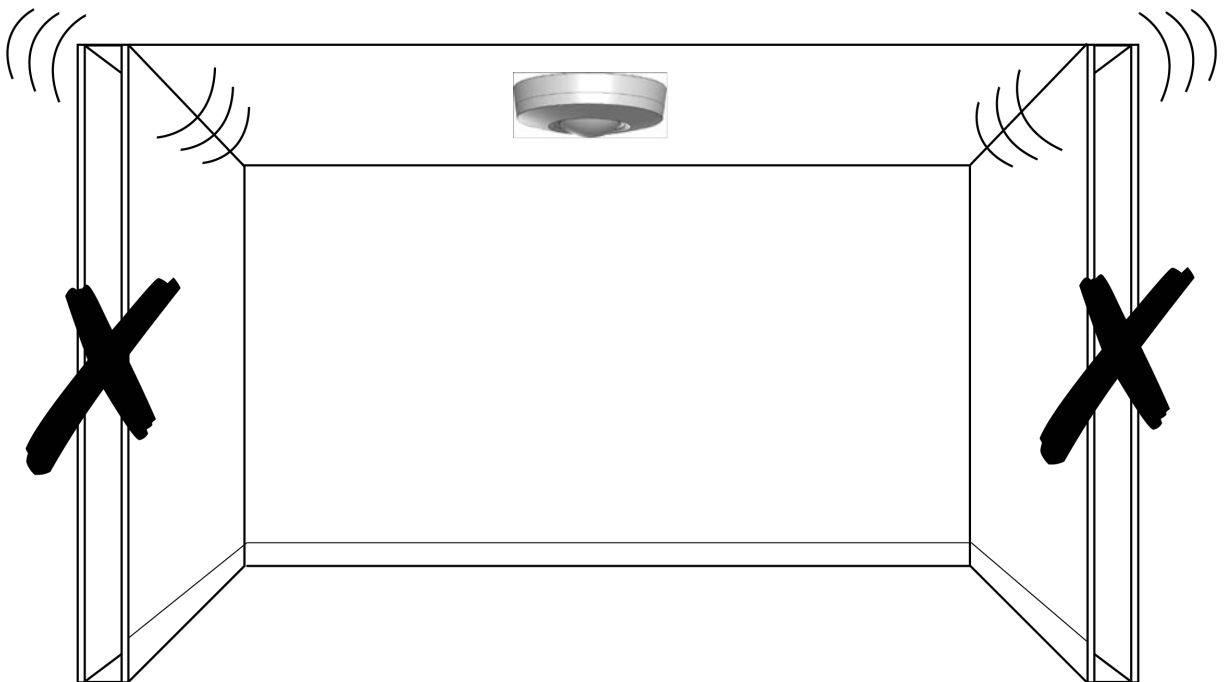

For internal use only

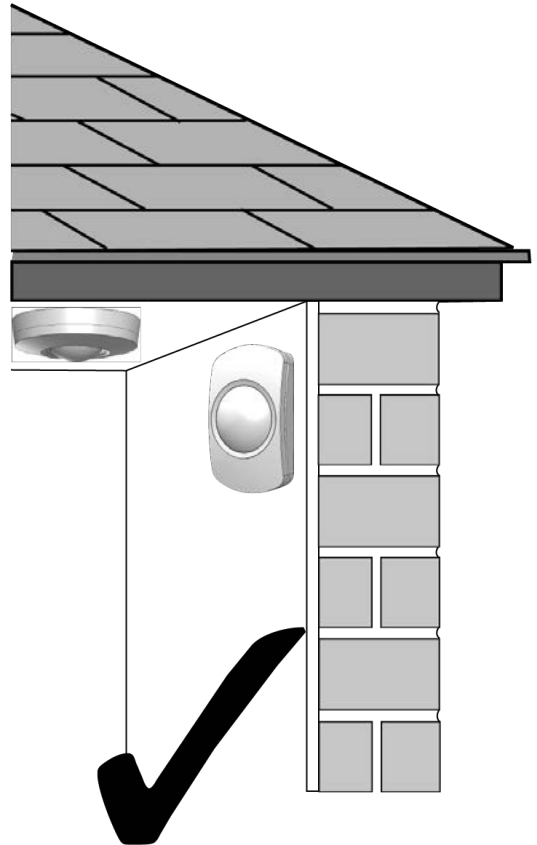
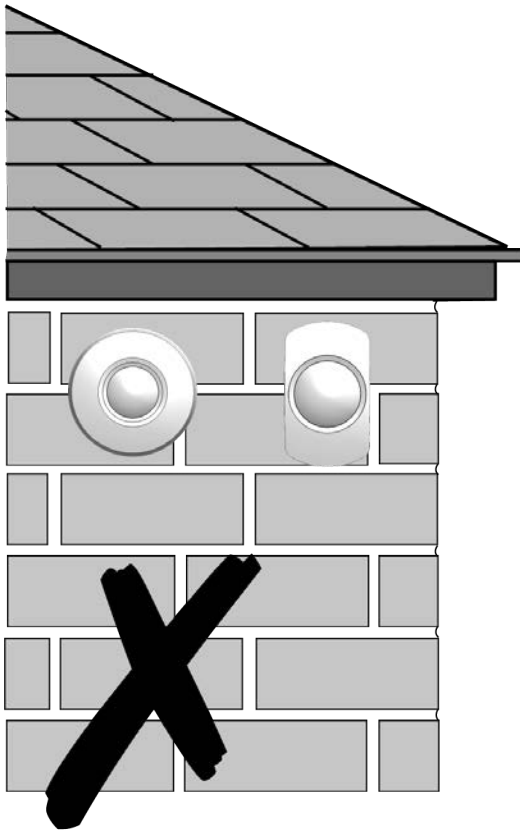

Screws & Fixings

A minimum of 2 opposing fixing holes should be used to ensure maximum stability. When corner mounting care should be taken to ensure the chassis is not twisted, if the corner is uneven then two fixings on the same side would be acceptable. Where removal from mounting detection is required you must ensure that the tamper fixing is opposite to at least one of the corner or wall fixings.

Dependent on the mounting substrate, suitable fixings may be required. The size and type will depend on the choice of fixing screw.

- Minimum screw size 3.5 X 16mm CSK
- Maximum screw size 4.0 X 70mm CSK

Cable Routing

If the bottom cable entries are used, care should be taken to ensure that the cable

passes around the post as shown. This helps avoid cable snagging when refitting the front chassis.

NOTE: Do not use the screw fixing points to route cable.

Corner mount

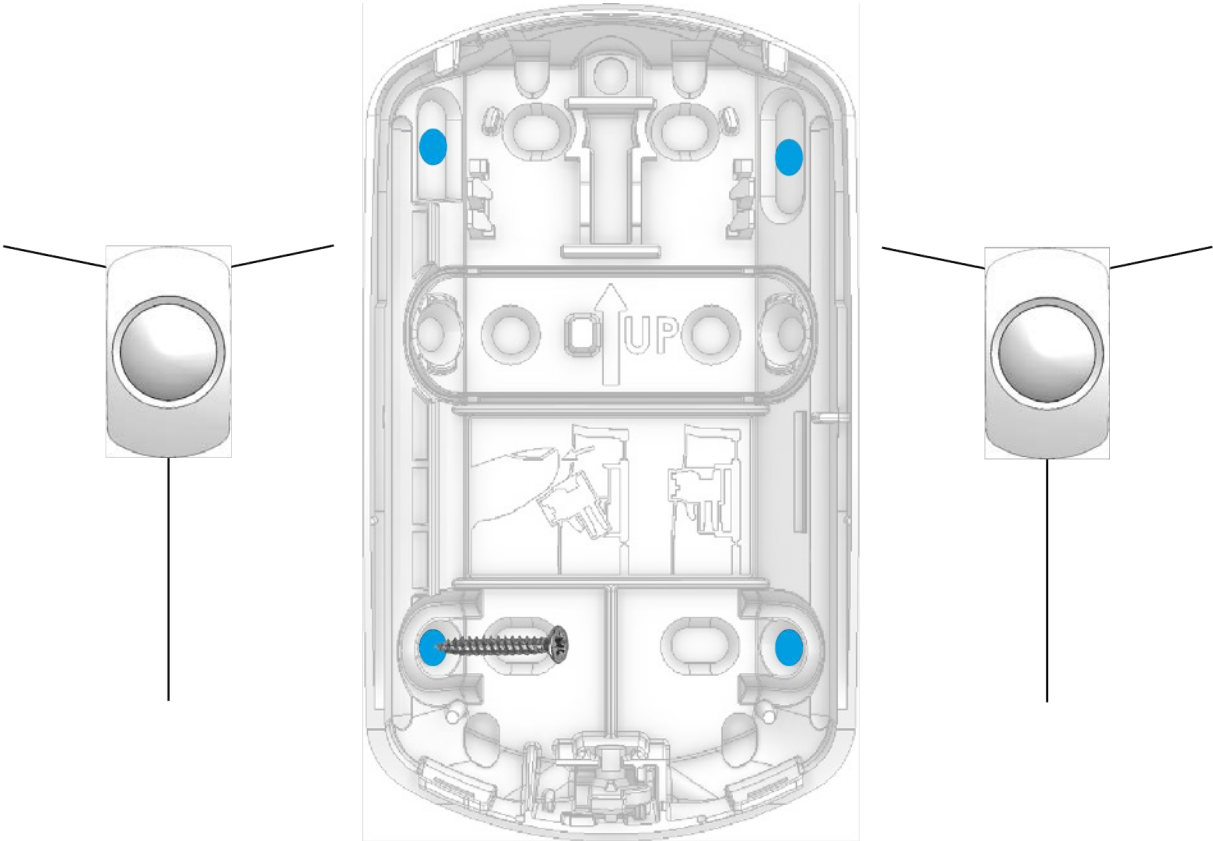

Wall, ceiling & flat surface mount

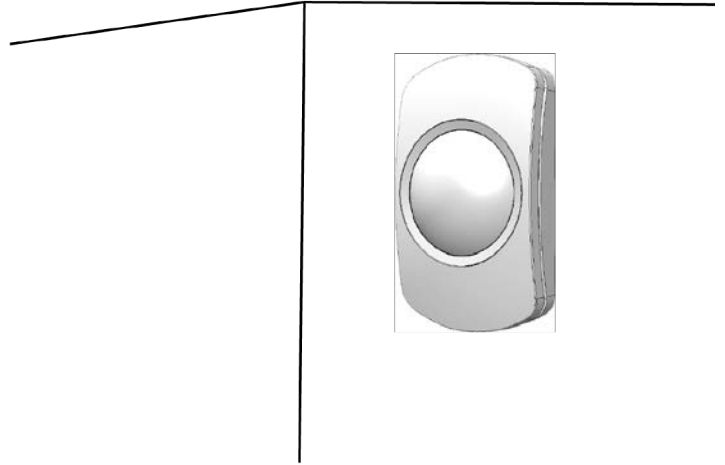
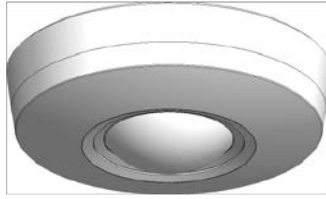
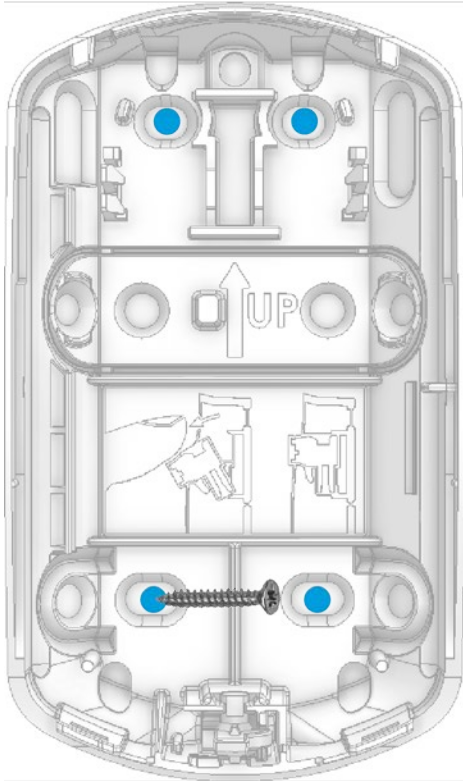

Cable routing

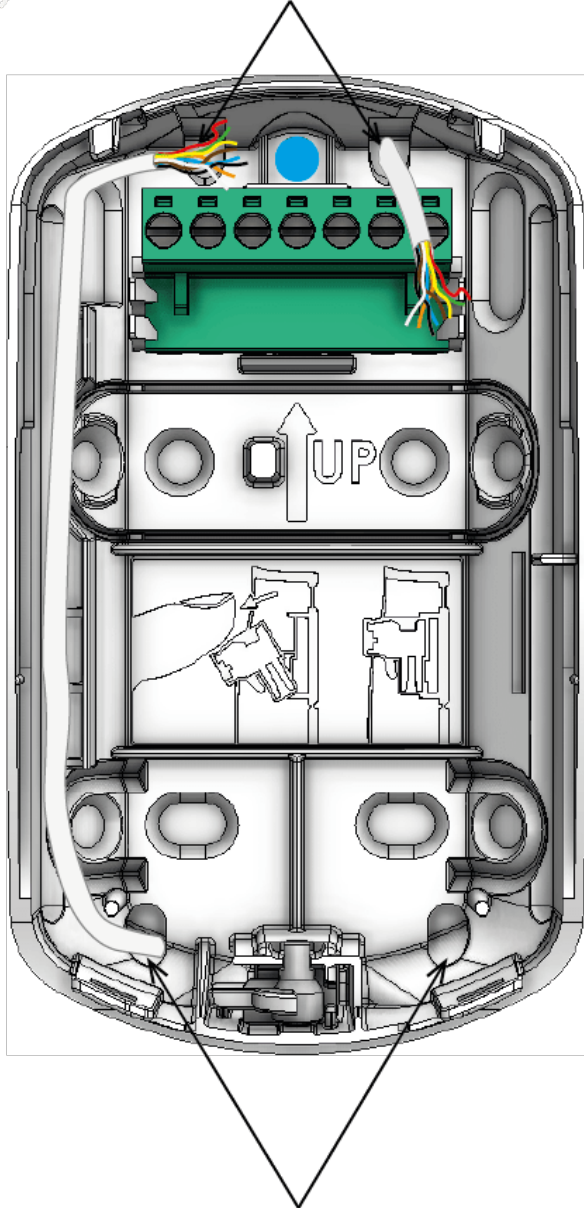
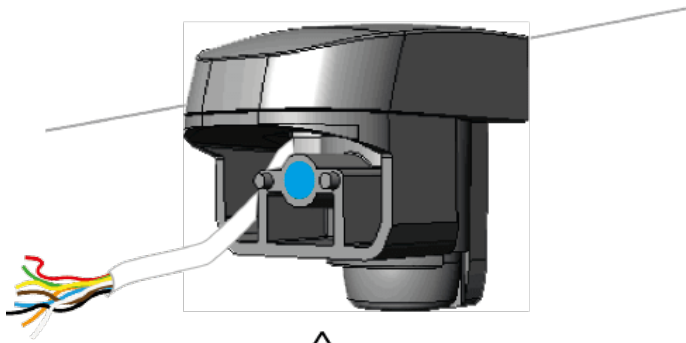

Terminal block tilt

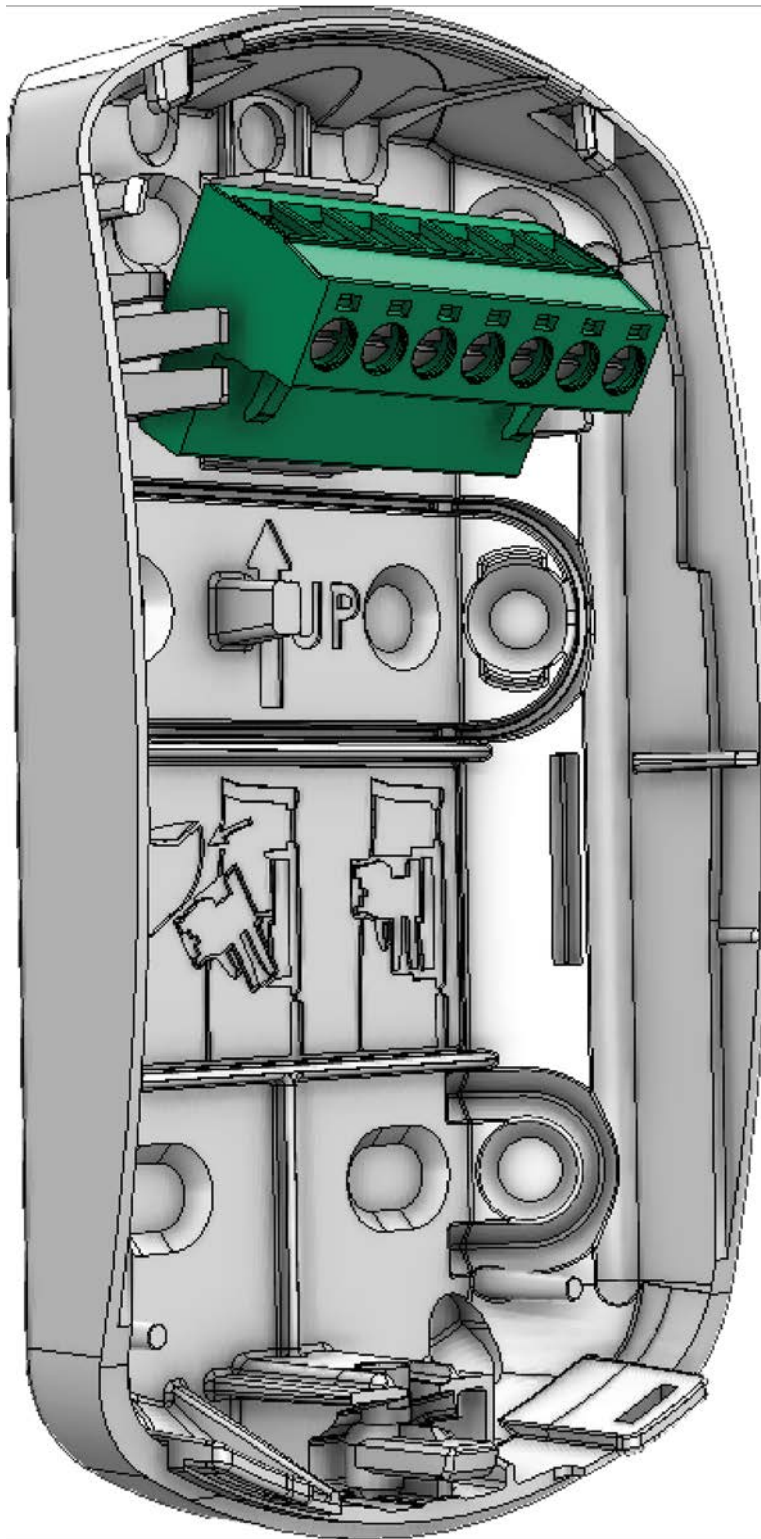

1.3 Wiring and EOL selection

The device allows you to wire to control equipment in several different ways. To aid wiring and inspections of cable termination the terminal block can be tilted forwards or removed entirely.

EOL wiring is considered the most secure. The example shown assumes you are connecting to a Premier Elite control panel. For other wiring types, please refer to the manufacturer's instructions for your equipment.

The device is defaulted to the **Texecom** EOL values. Use a terminal driver to move the switch to any other position.

The O/C position can be used for other wiring types, including use of resistor values which are not included on the device Terminal block identification.

Terminal block identification

1. - to Aux 0V
2. + to Aux 12V
3. A - Alarm
4. B - Alarm
5. C - Tamper
6. D - Tamper
7. RLED can be used to control the LED for walk testing.

Terminal block

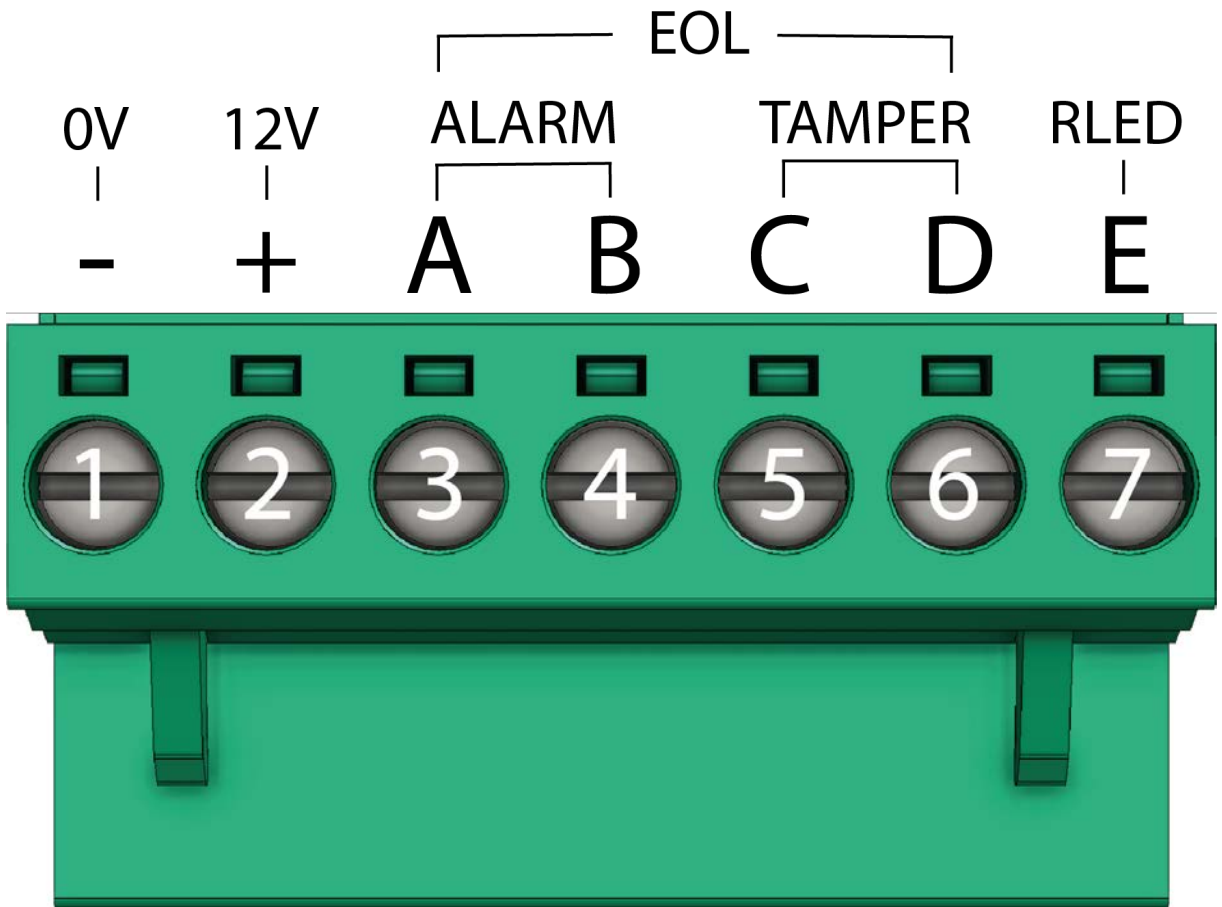

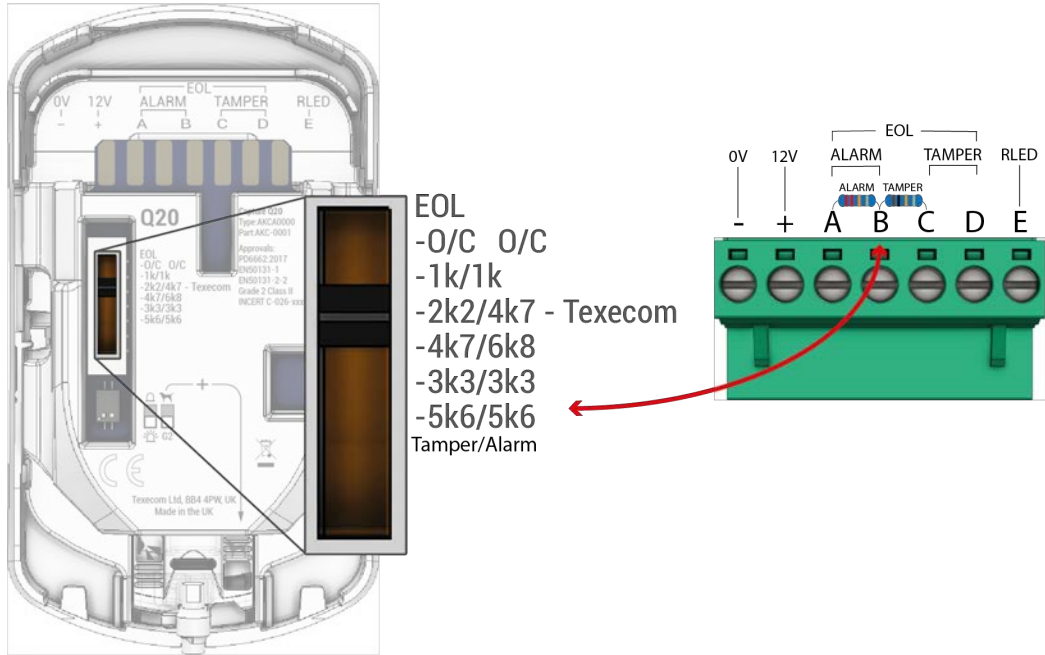

EOL wiring to a Premier Elite 24 & 64-W

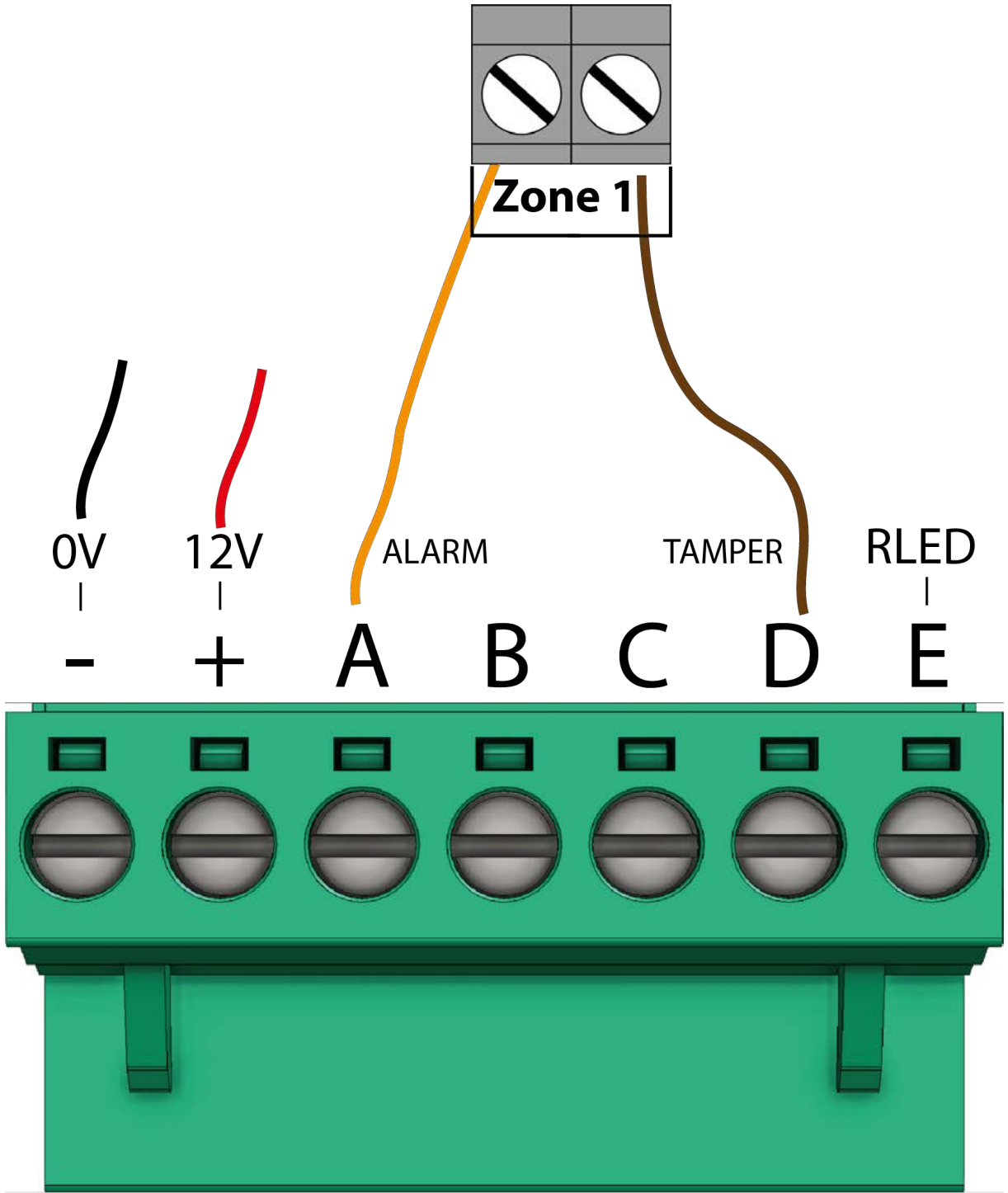

EOL wiring to a Premier Elite 48 & 640

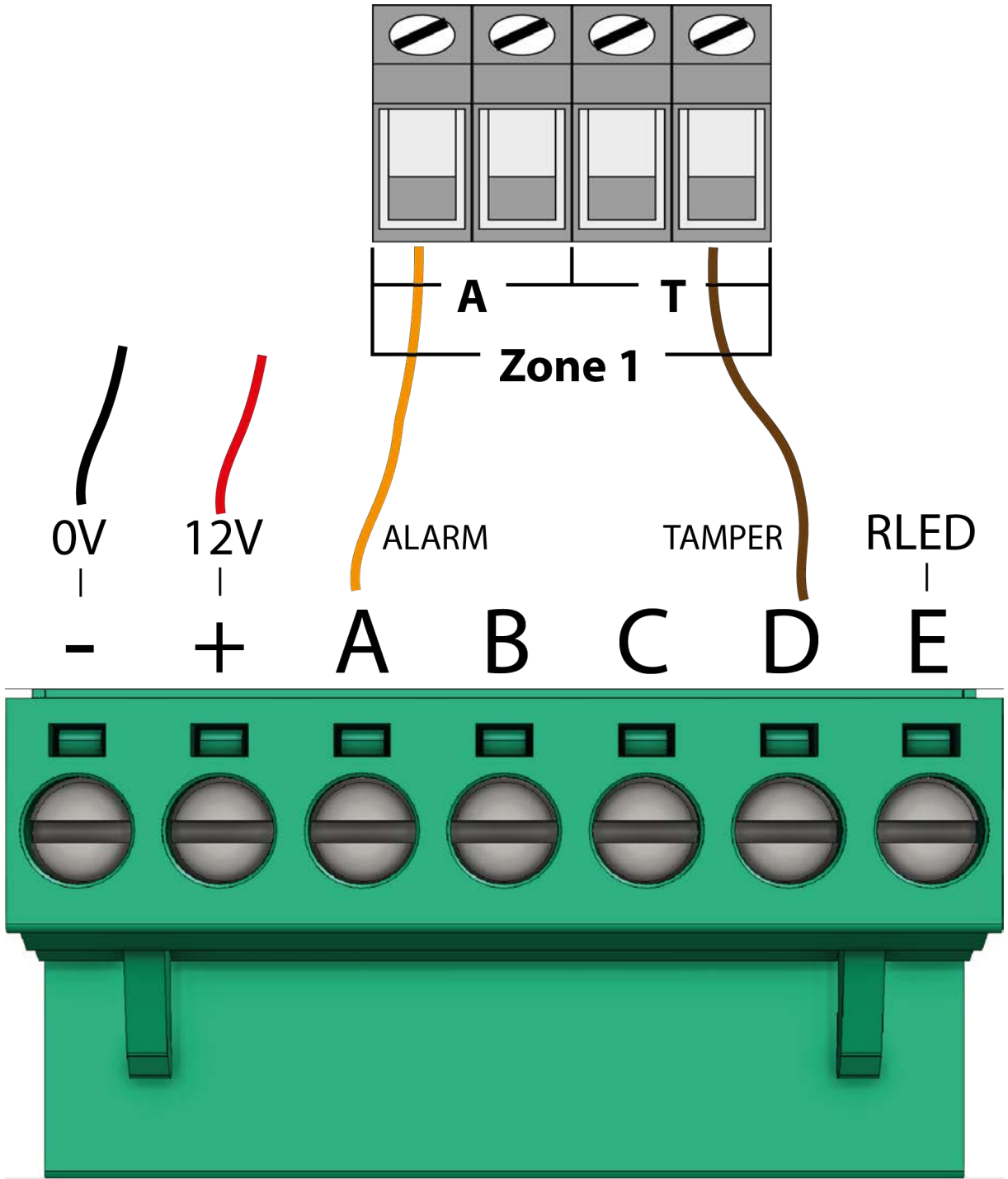

RLED terminal

The RLED (Remote LED) terminal can be used to control the LED for walk testing

from the panel.

To use the RLED feature put switch 1 in the up position which will disable the LED. When an output is triggered 0V is applied to the RLED terminal which will enable the LED. On a Texecom control panel the output can be programmed as either Engineer Logon or Walktest.

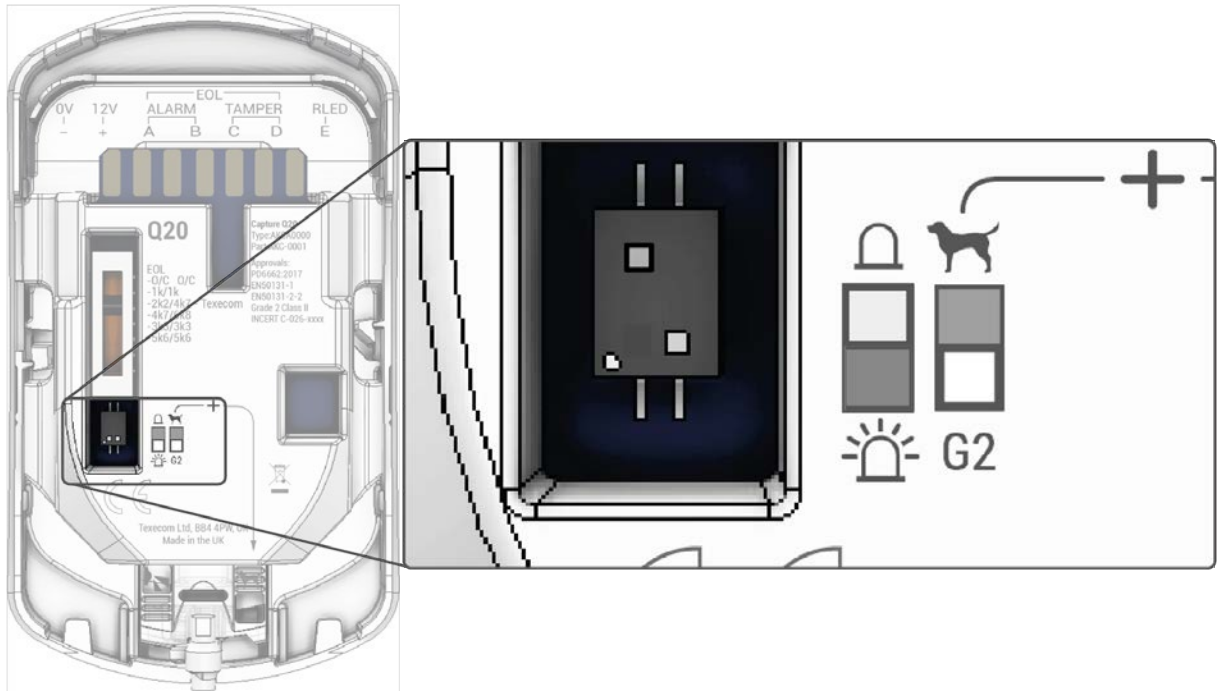

1.4 Mode selection

G2 all models (Q20 shown)

This is the default state for optimum catch performance and false activation immunity. Switch 2 and the lens obscuration slider should be in the down position.

- P15 15m @ 90° compliant to EN50131-2-2, INCERT and PD6662
- Q20 20m @ 90° compliant to EN50131-2-2, INCERT and PD6662
- D20 20m @ 85° compliant to EN50131-2-4, INCERT and PD6662

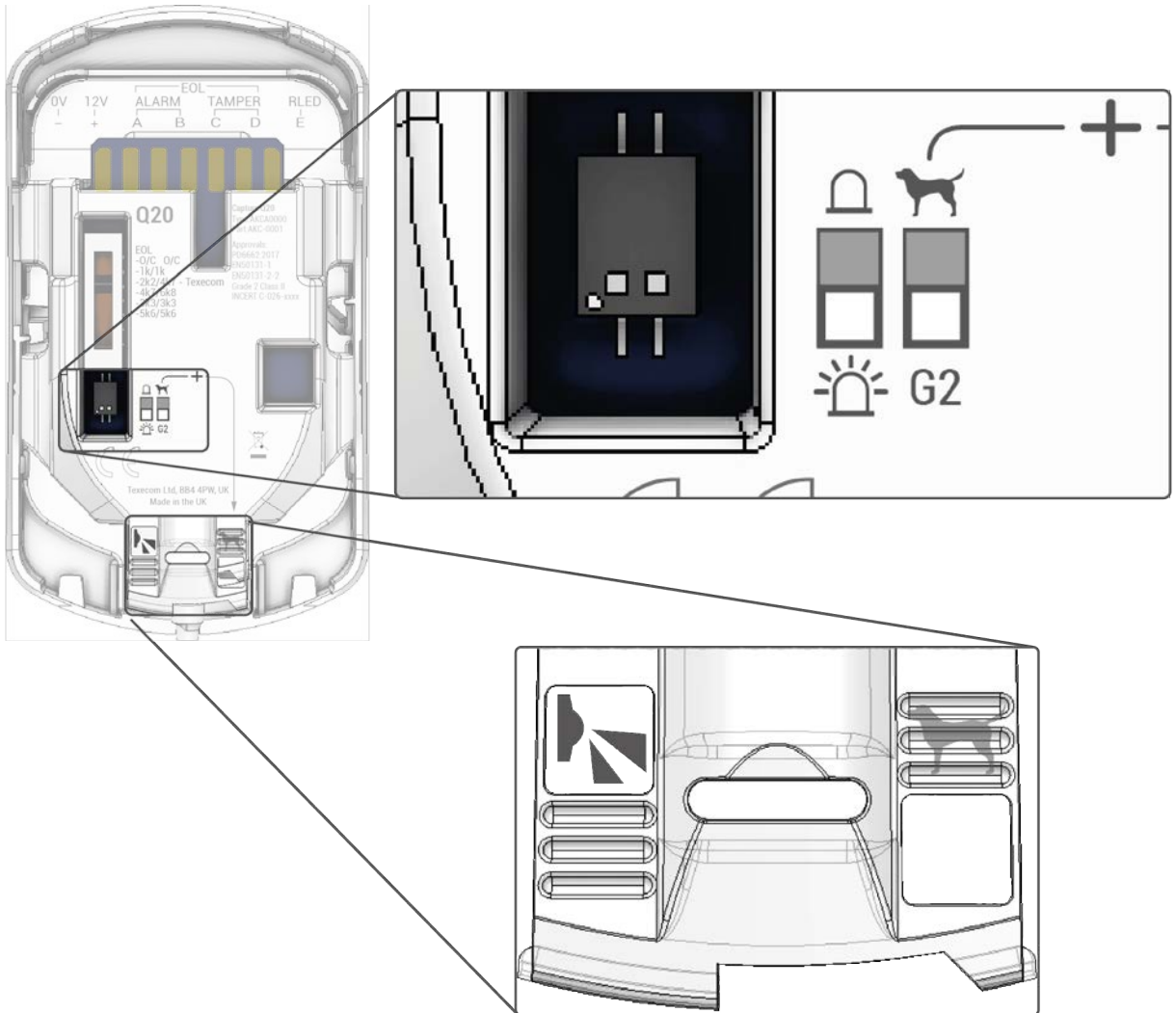

Pet Mode (P15, Q20 & D20)

When using Pet mode, switch 2 and the lens obscuration slider should both be placed in the UP position.

- P15 10mtr @ 90° up to 35kg pet immunity
- Q20 12mtr @ 90° up to 20Kg pet immunity (pending approval)
- D20 12mtr @ 85° up to 20Kg pet immunity (pending approval)

Note: Never use CloakWise with PET mode.

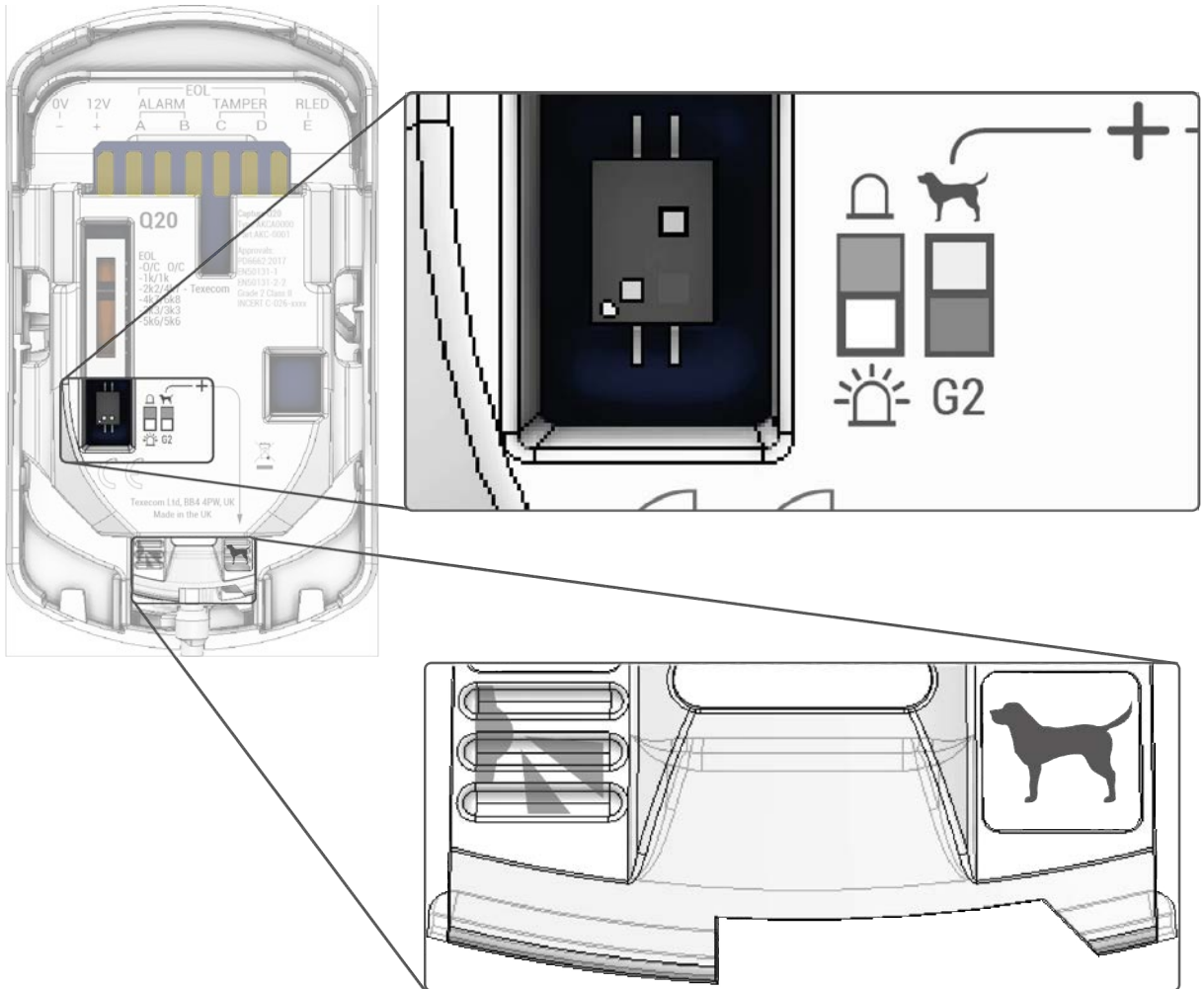

Cloakwise™ D20 & CD

Cloakwise is a proprietary detection algorithm, unique to Texecom, that can distinguish the presence of an intruder even if the unauthorised person attempts to mask or 'cloak' their presence. Utilising advanced signal processing techniques to both microwave and PIR channels, the Cloakwise technology can recognise cloaking attempts and detect accordingly. CW mode will also provide excellent detection when the ambient temperature is close to human body temperature.

Note: Never use Cloakwise with PET or LOW mode

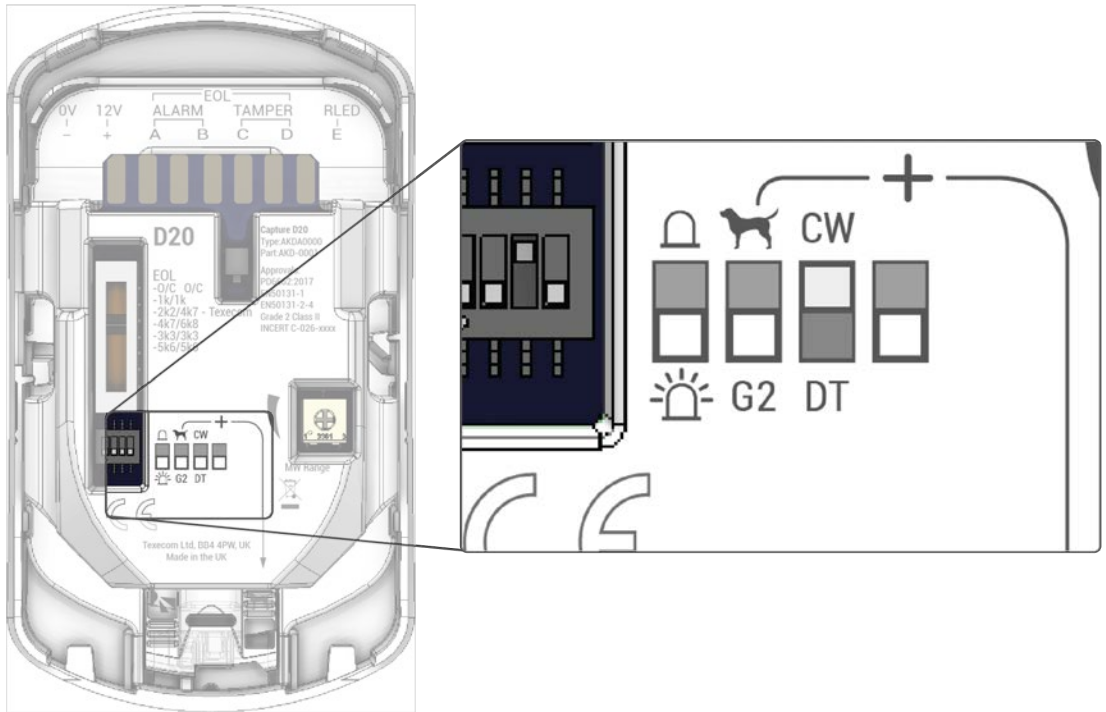

Low ceiling mount CQ & CD only

Low mode lowers the sensitivity of the device and provides greater false alarm immunity. Thorough walk testing across the entire protected area should be carried out to ensure catch performance is as expected.

Note: Never use CloakWise with LOW mode.

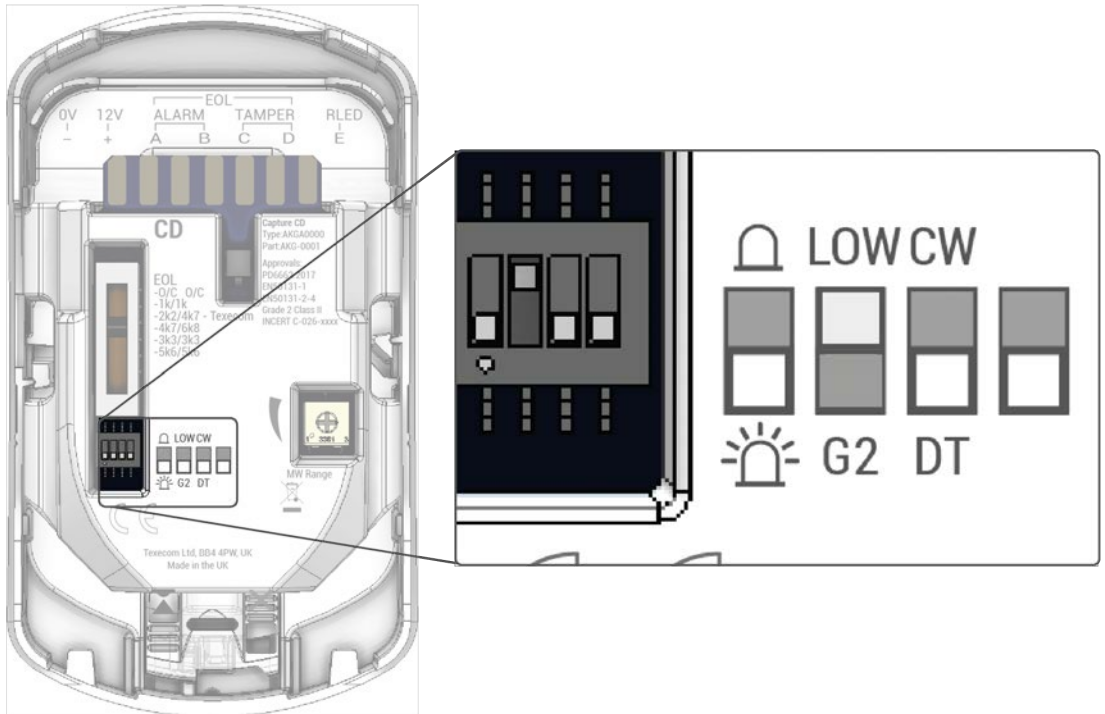

CQ & CD Slider

Leave in the default position

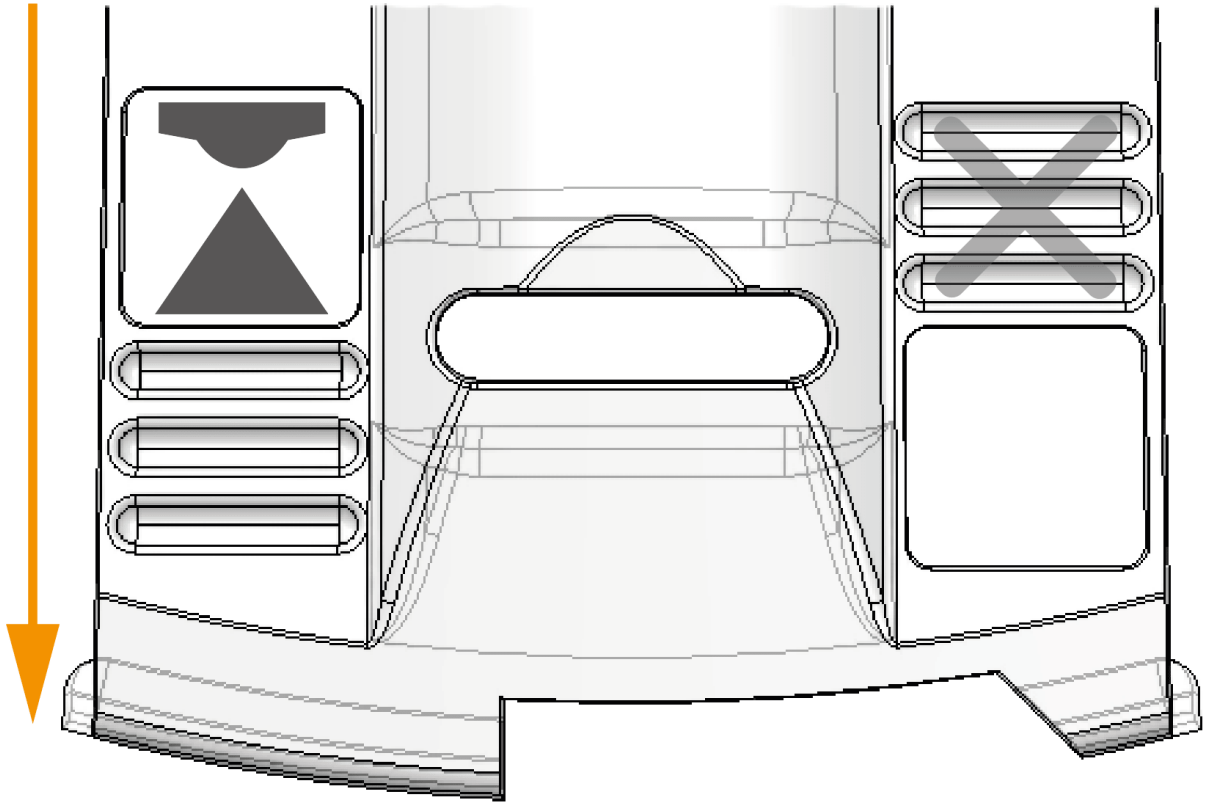



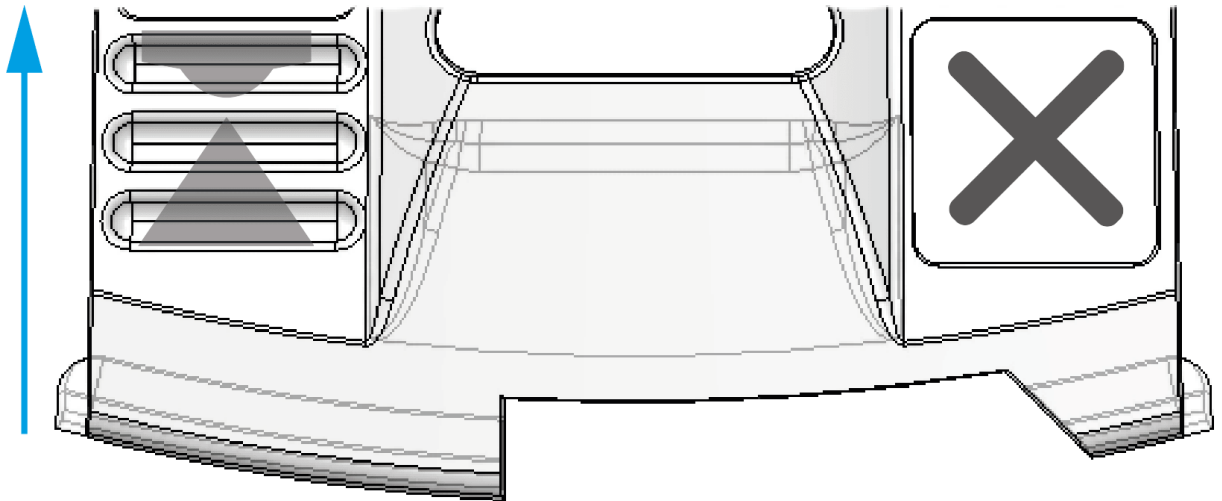

Do not use



1.5 Testing, commissioning & LED indications

When installation is complete, the device should be thoroughly walk tested to ensure the desired protection is being achieved, and any adjustments to the device are made to cater for the specific location and any local site conditions.

Note: LED's are disabled during normal use if the RLED switch is ON.

State	Colour	Flash
Warm up		Flash 0.5s on 0.5s off
Alarm		
PIR only on D20/CD		
MW only on D20/CD		

Walk test

Walk test all devices to ensure you have adequate coverage, and that there are no obstructions in the detection area.

D20 & CD Microwave Range Adjustment

Devices are supplied with the microwave adjustment potentiometer set at the mid-point.

The microwave should be adjusted according the area to be protected, and great care should be taken to ensure the microwave cannot “see” beyond protected area. LED indication of the microwave pickup allows for accurate setting of the detection area.

- Power up the device
- Walk test the device taking note of the LED indications.
- Adjust the Microwave range until the desired coverage is achieved.

D20 Microwave Coverage

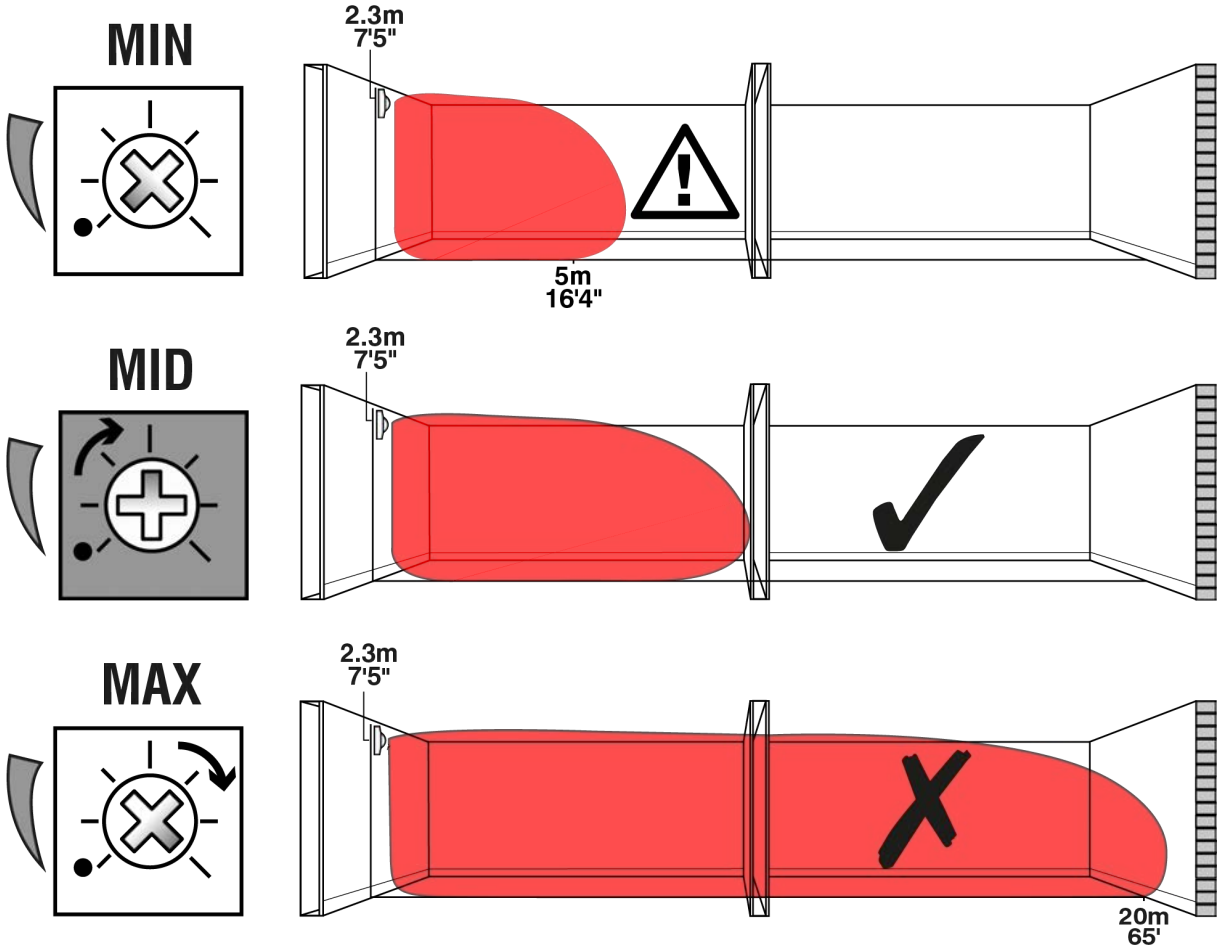

CD Microwave Coverage

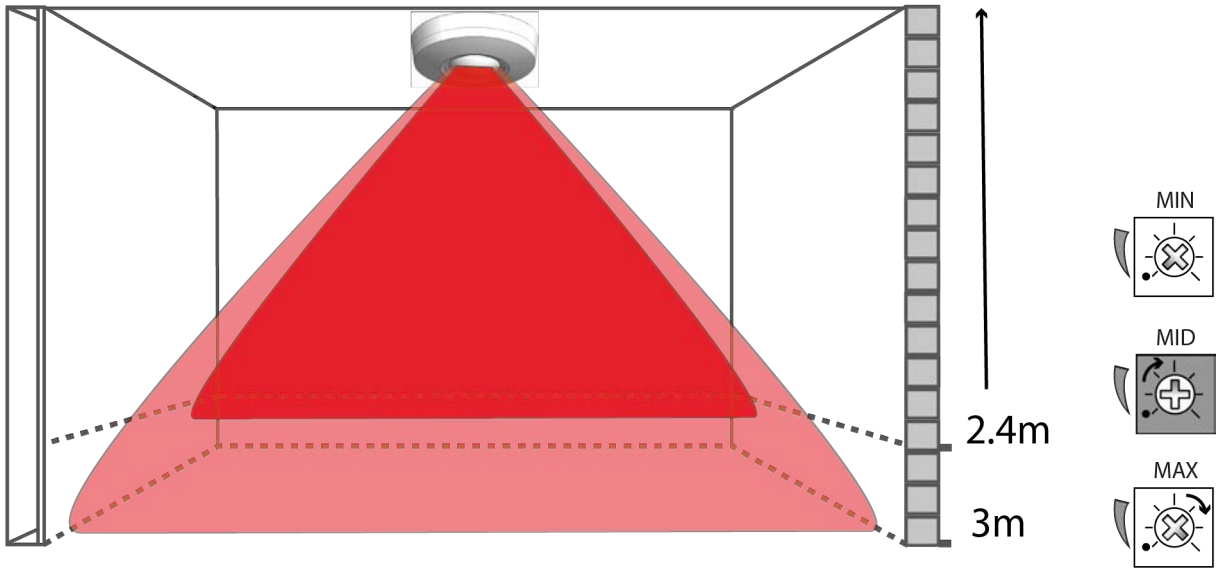

Resistance & voltage readings

Resistance and voltage readings should be recorded at the time of installation.

- Voltage readings should be taken at the device
- Resistance reading should be taken at the CIE or ACE where the circuit is terminated.

2.0 Variants

2.1 CAPTURE P15

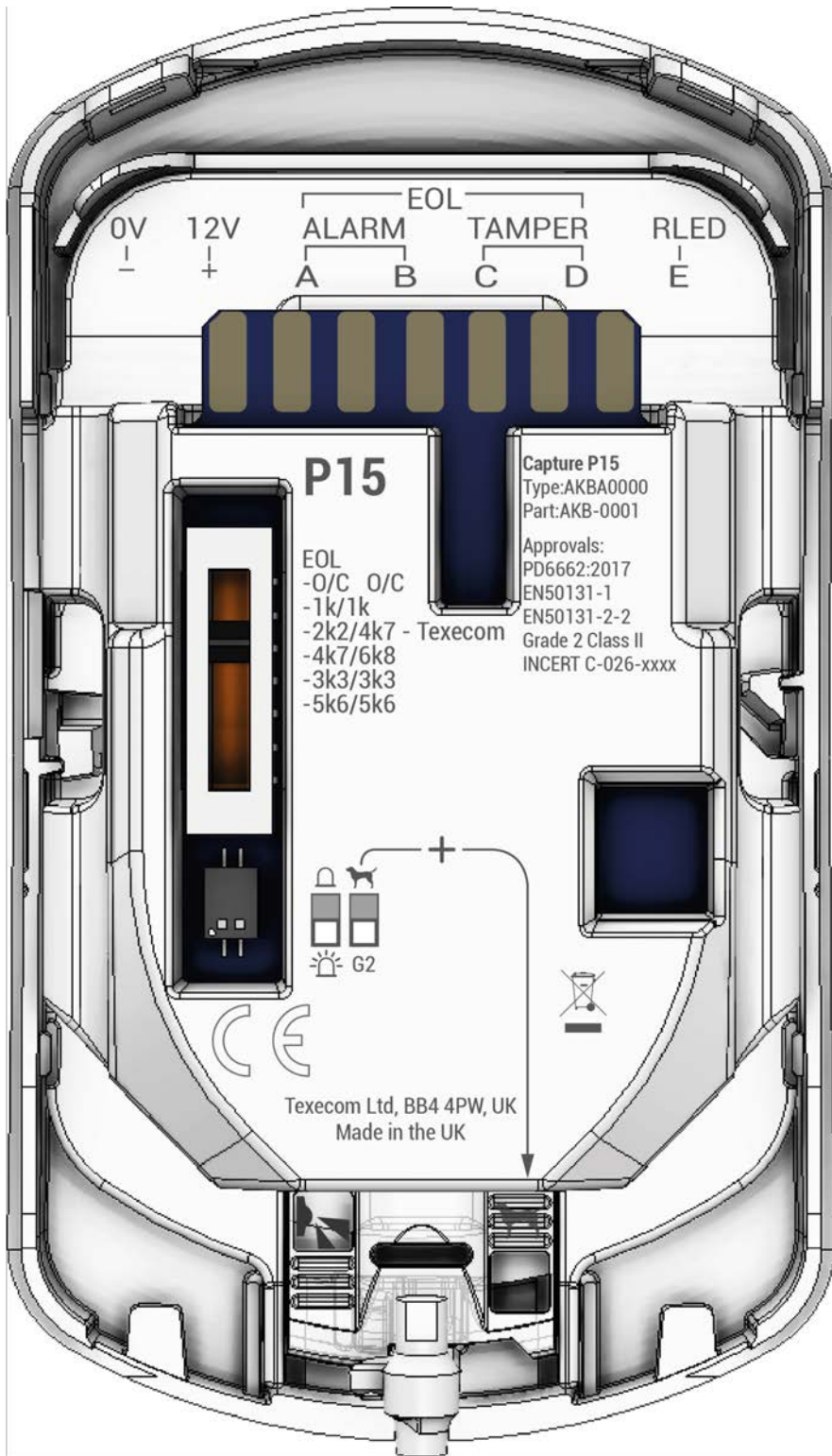

G2 Coverage

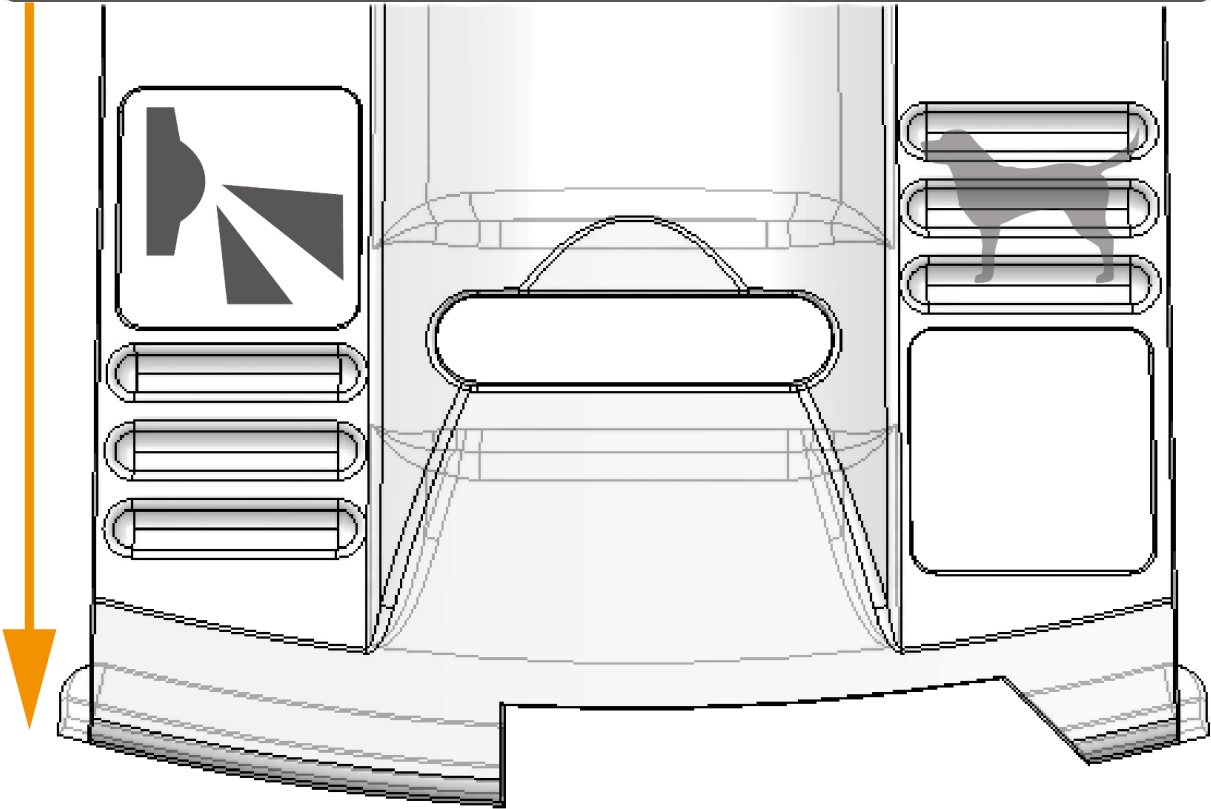
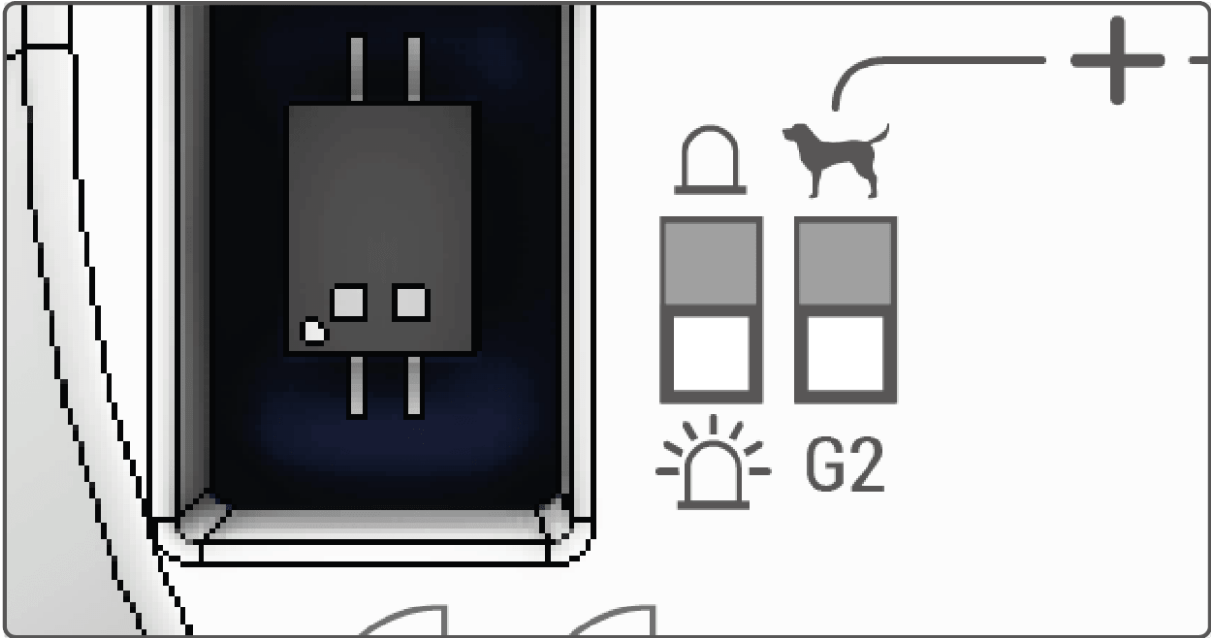

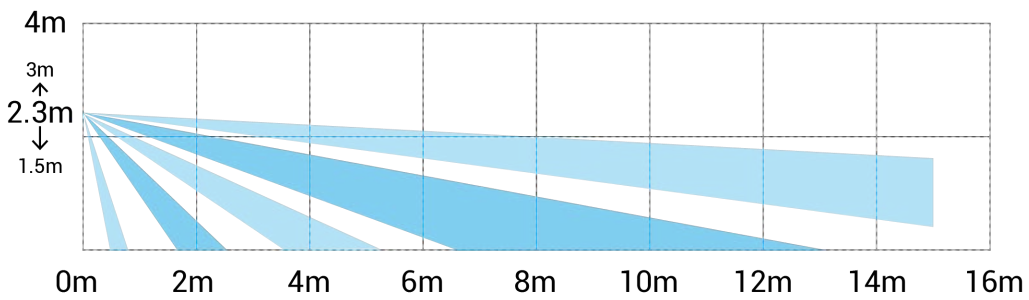
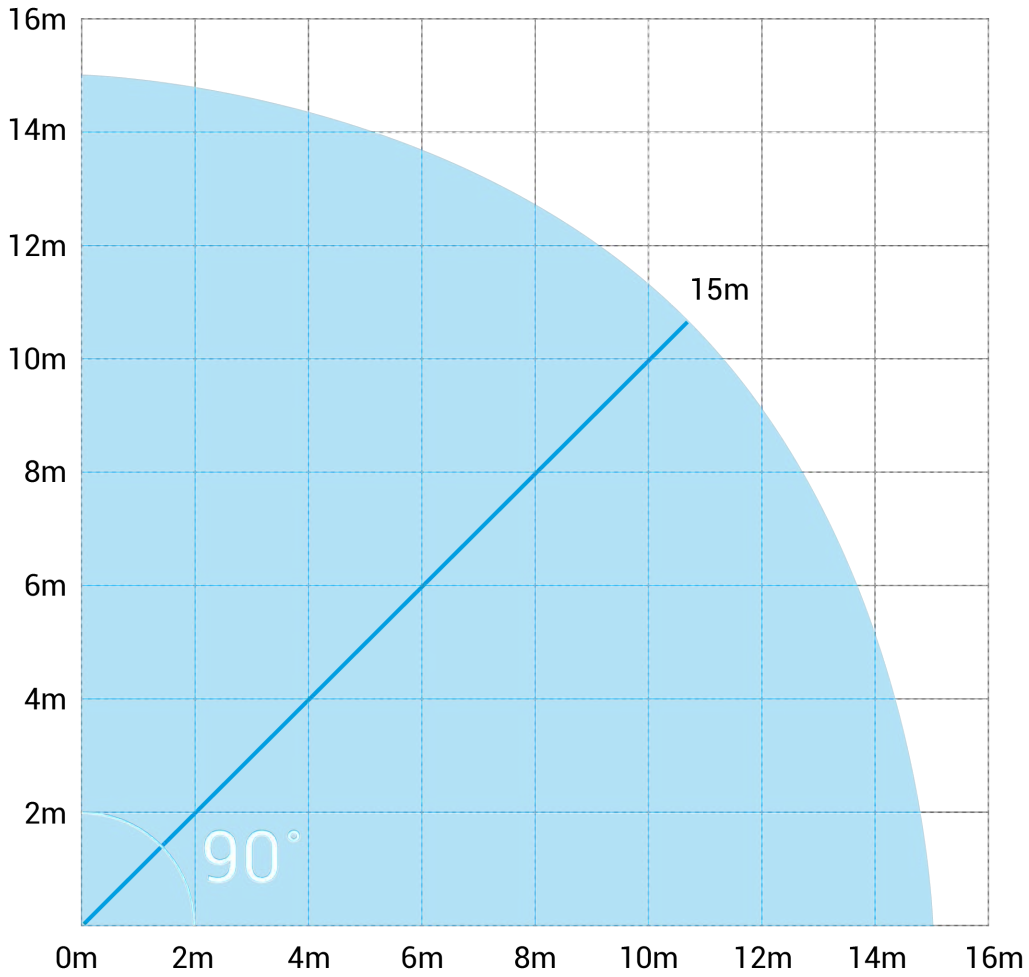

Pet coverage

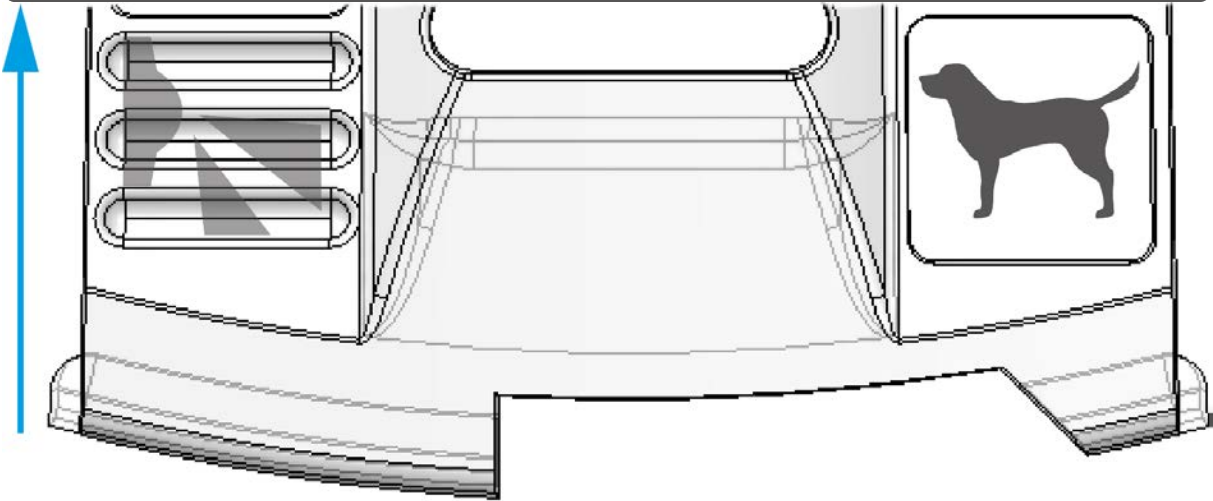
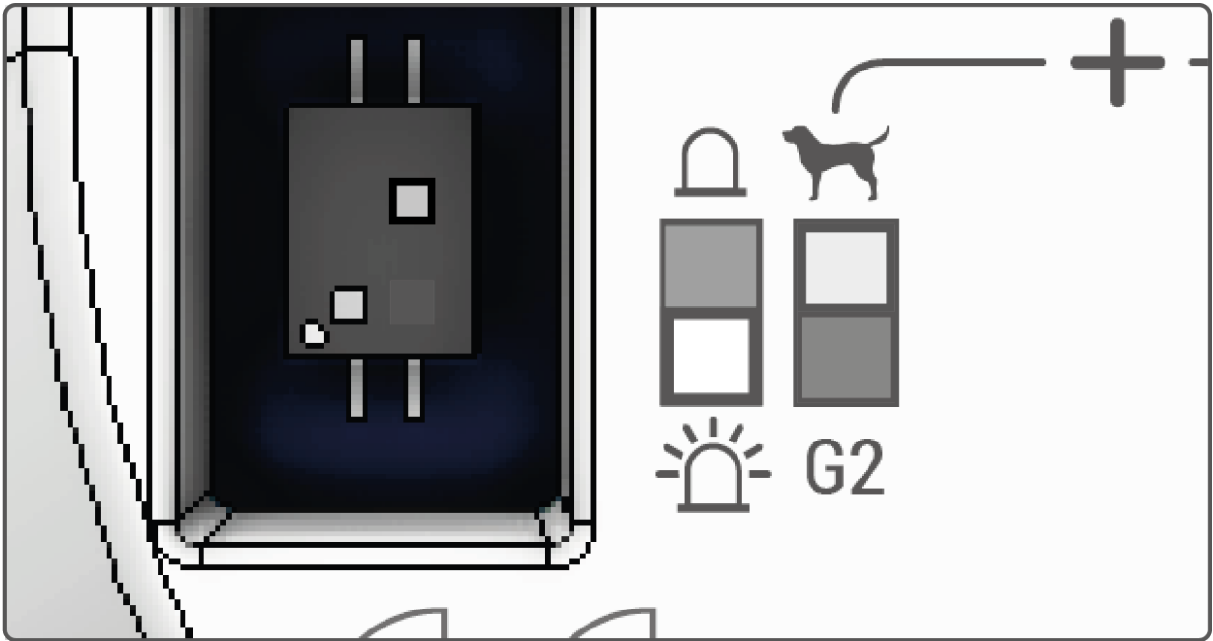

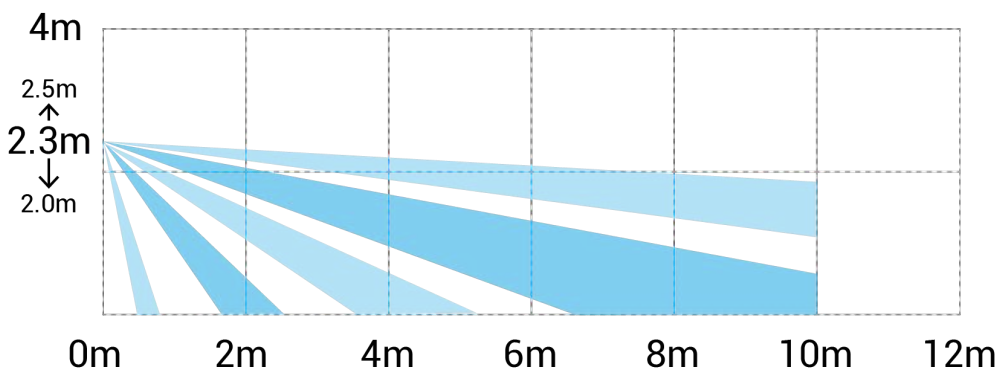
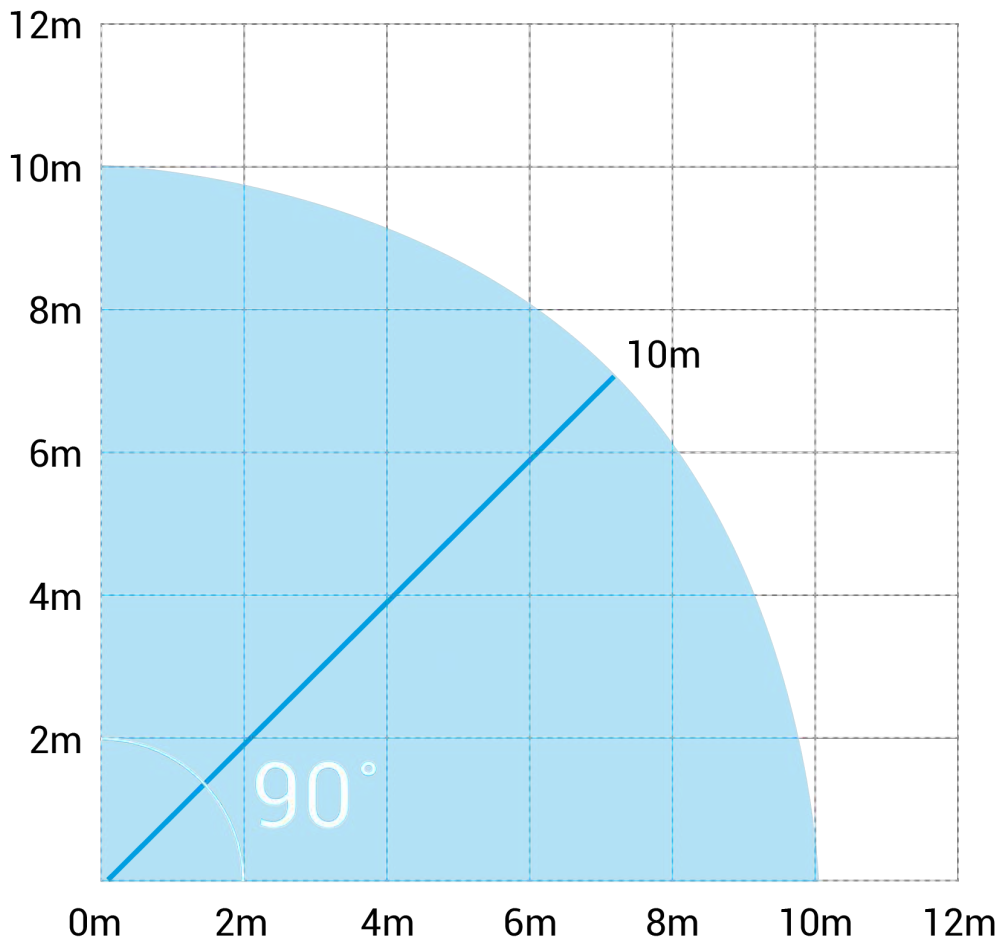

2.2 CAPTURE Q20

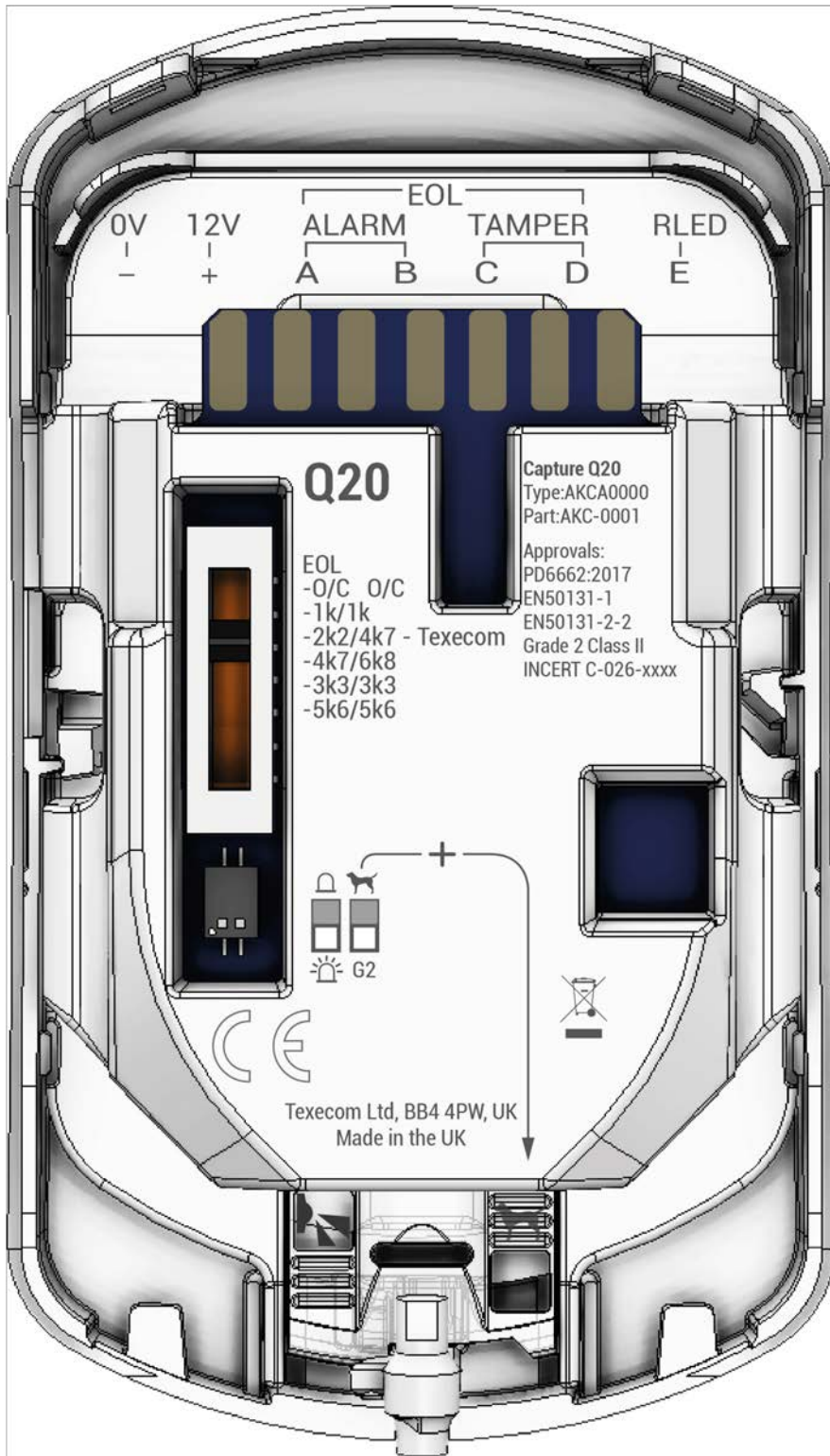

G2 Coverage

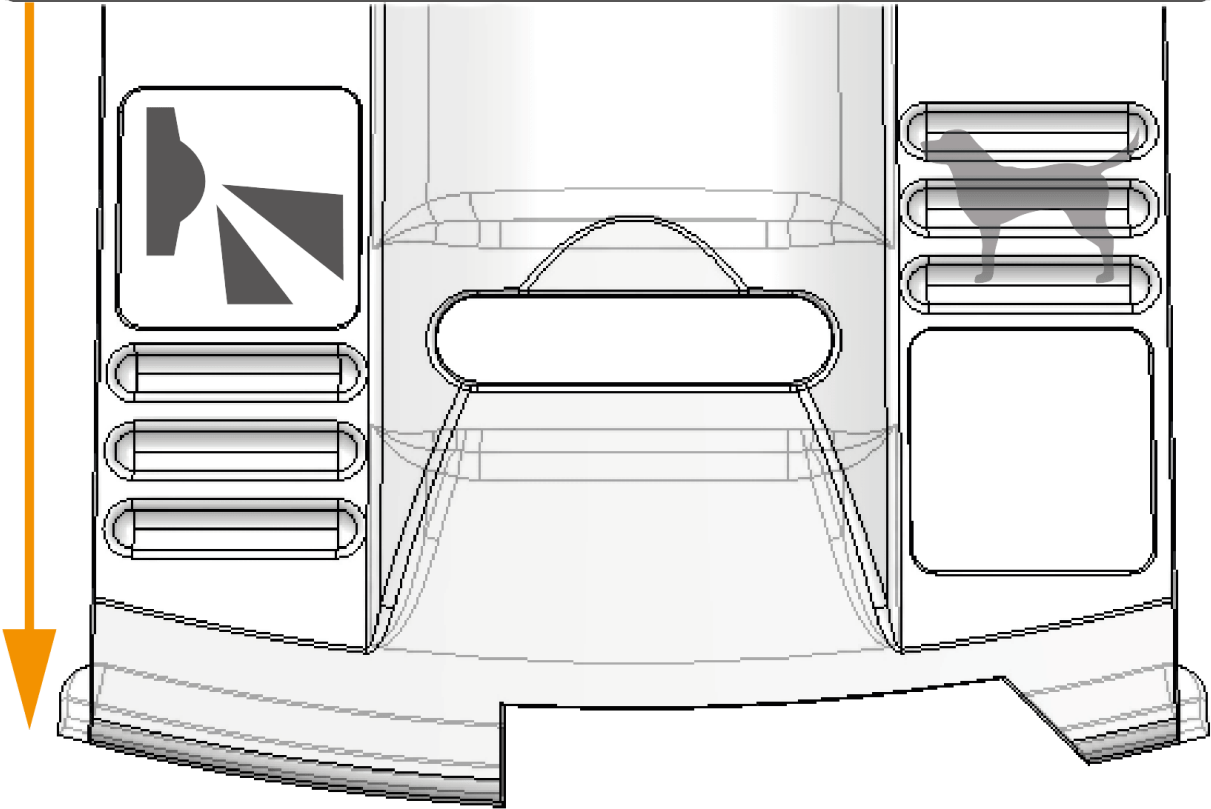
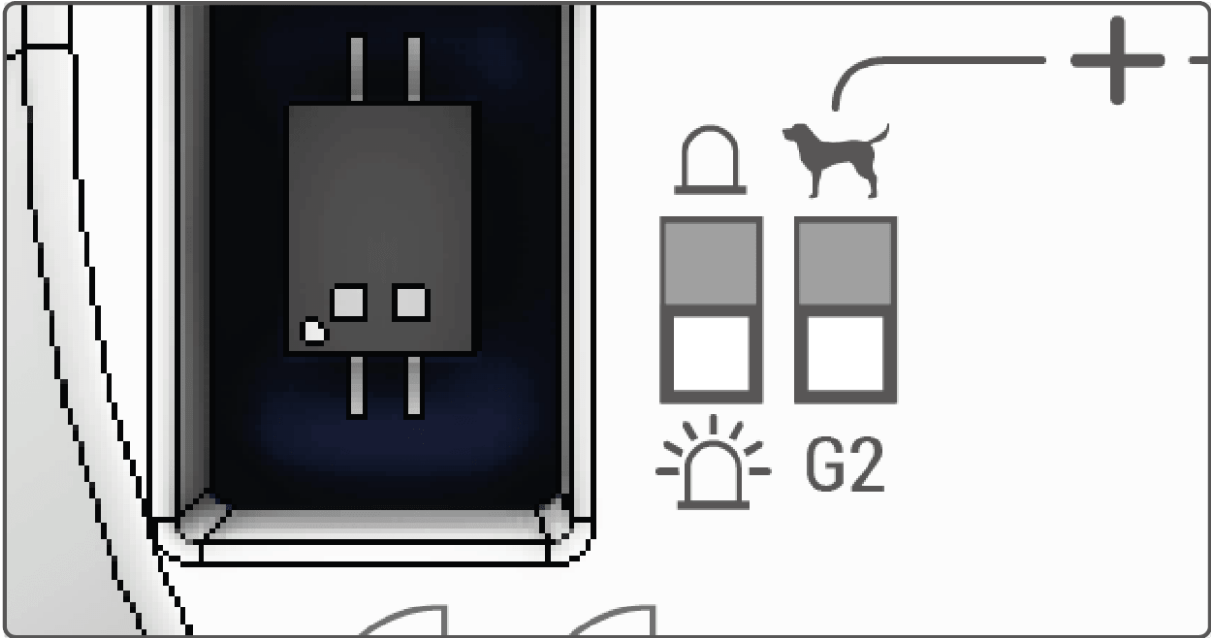

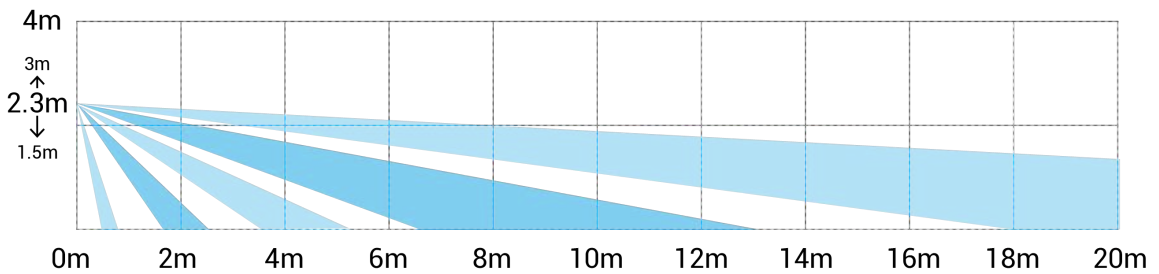
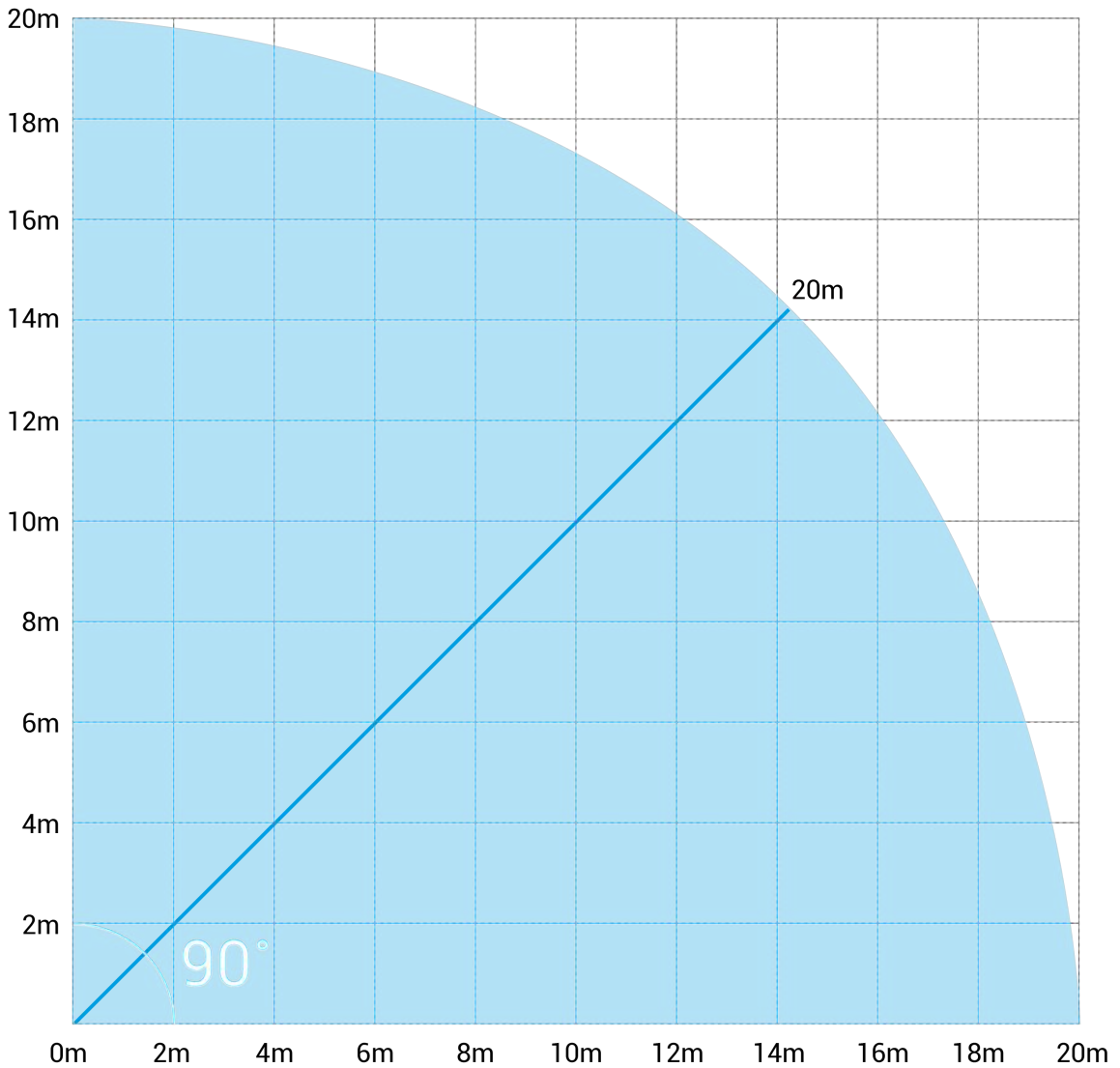

Pet coverage

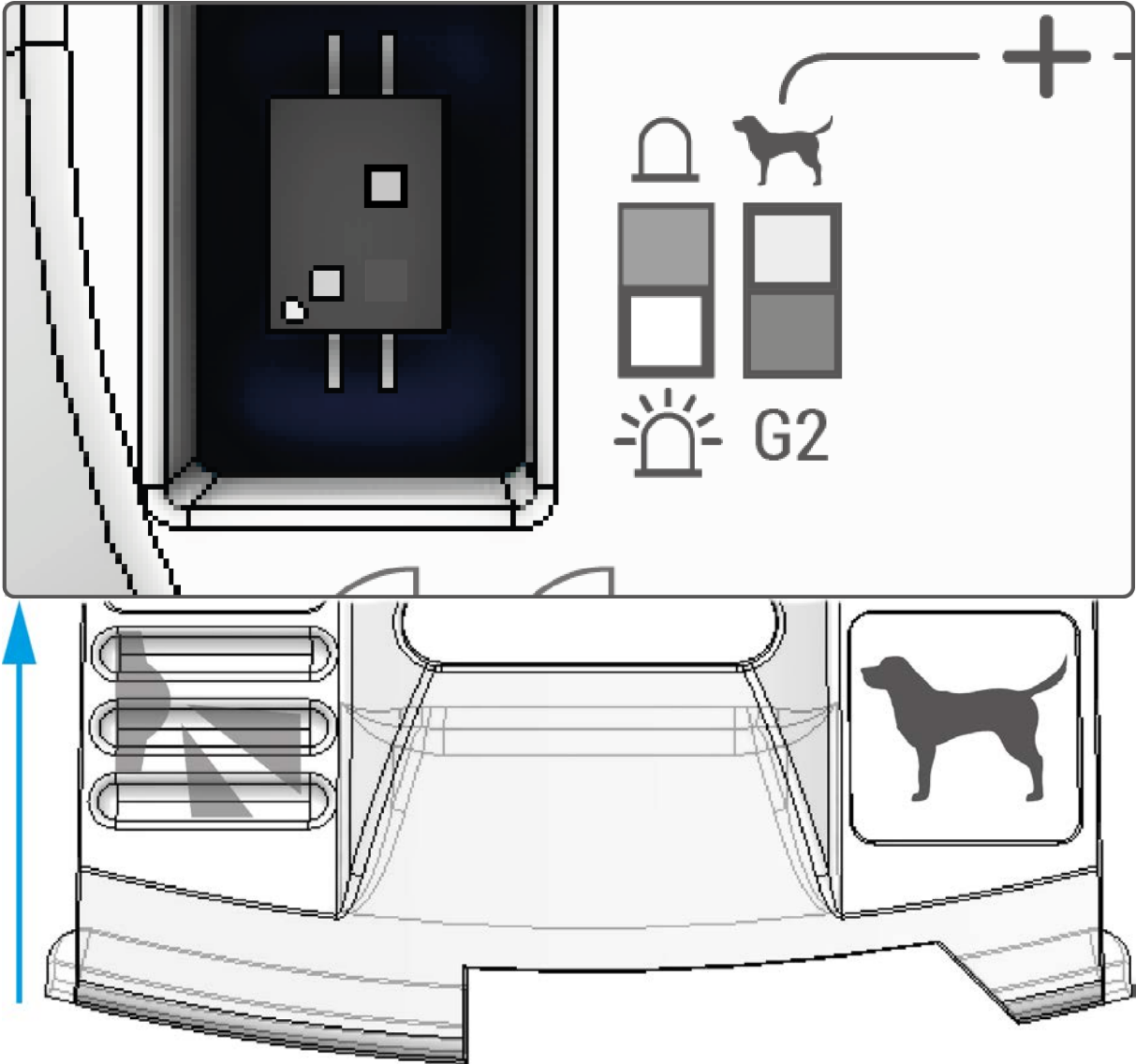

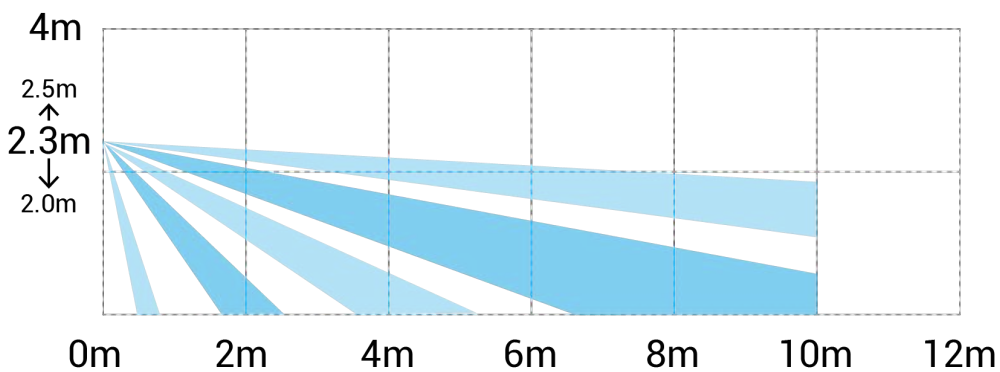
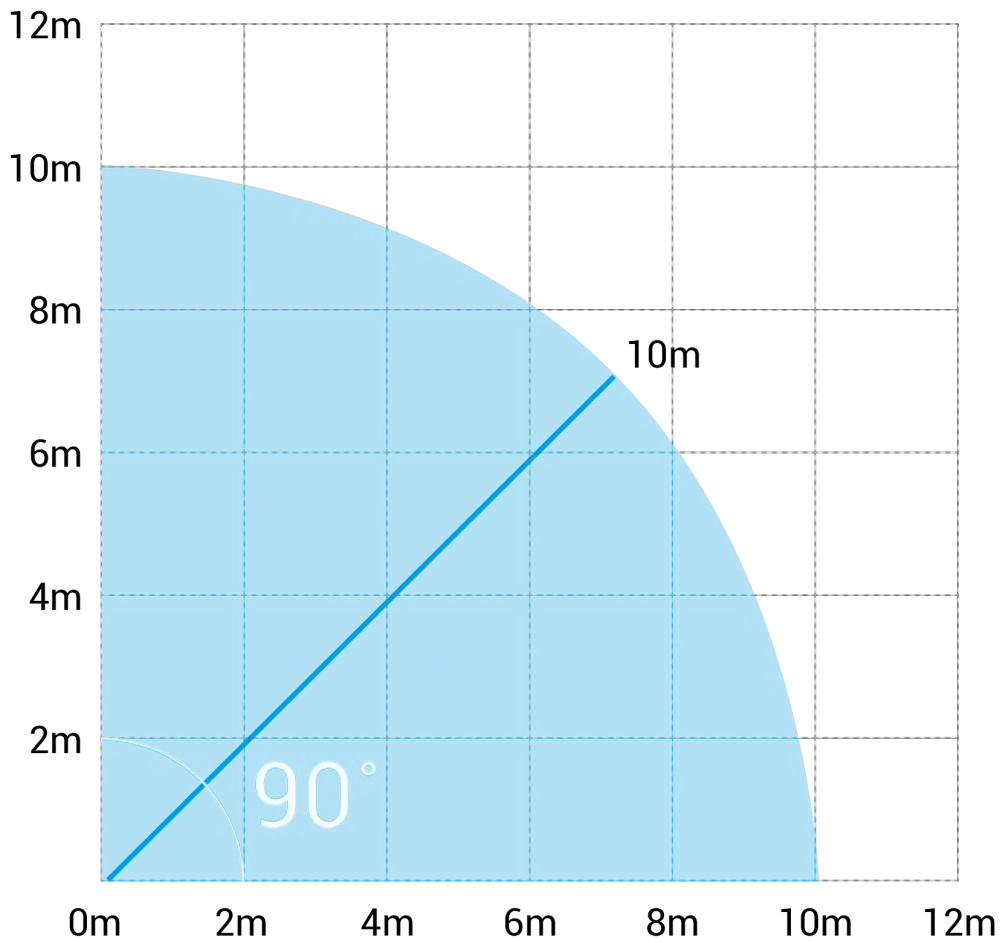

2.3 CAPTURE D20

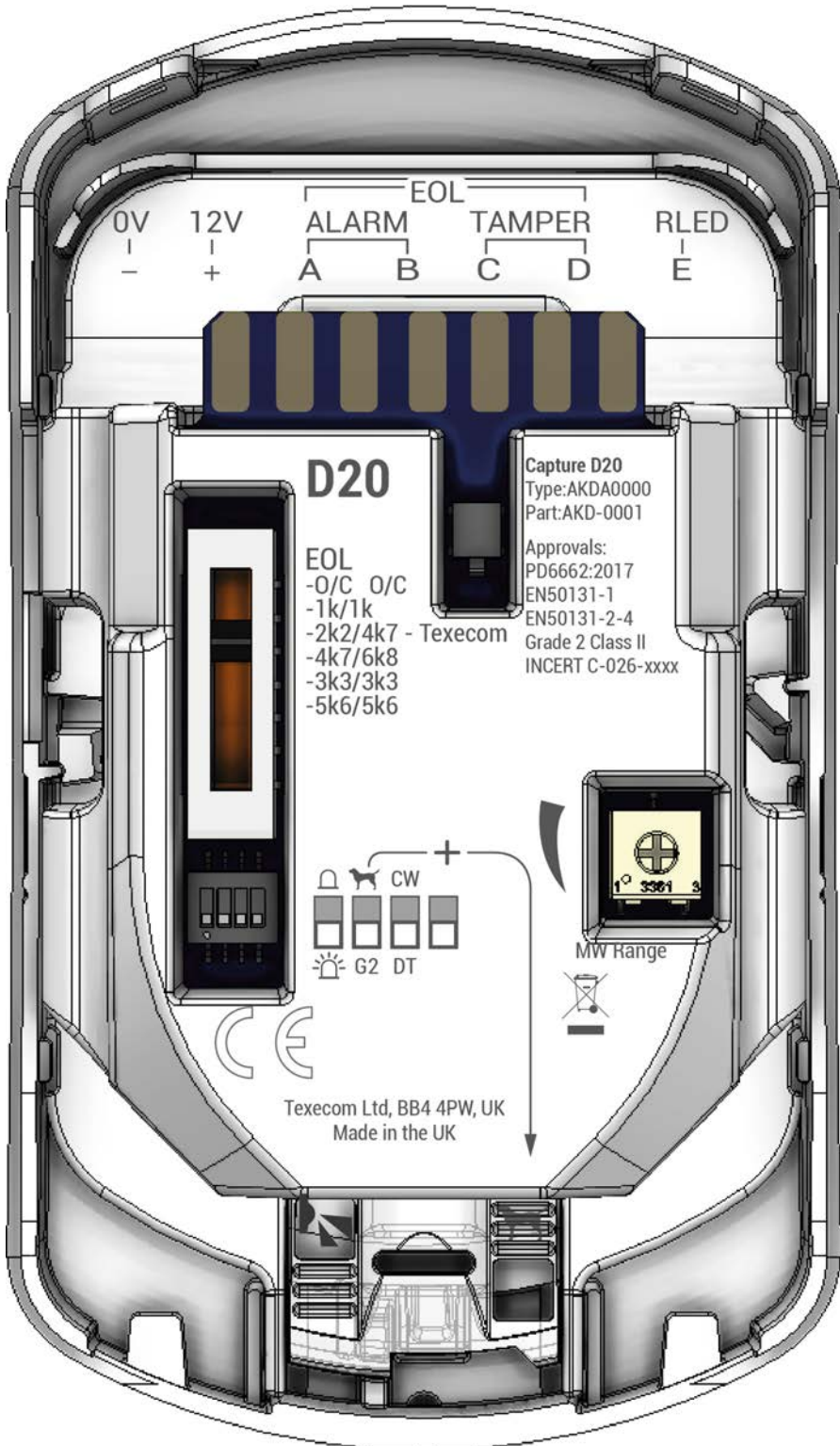

G2 coverage

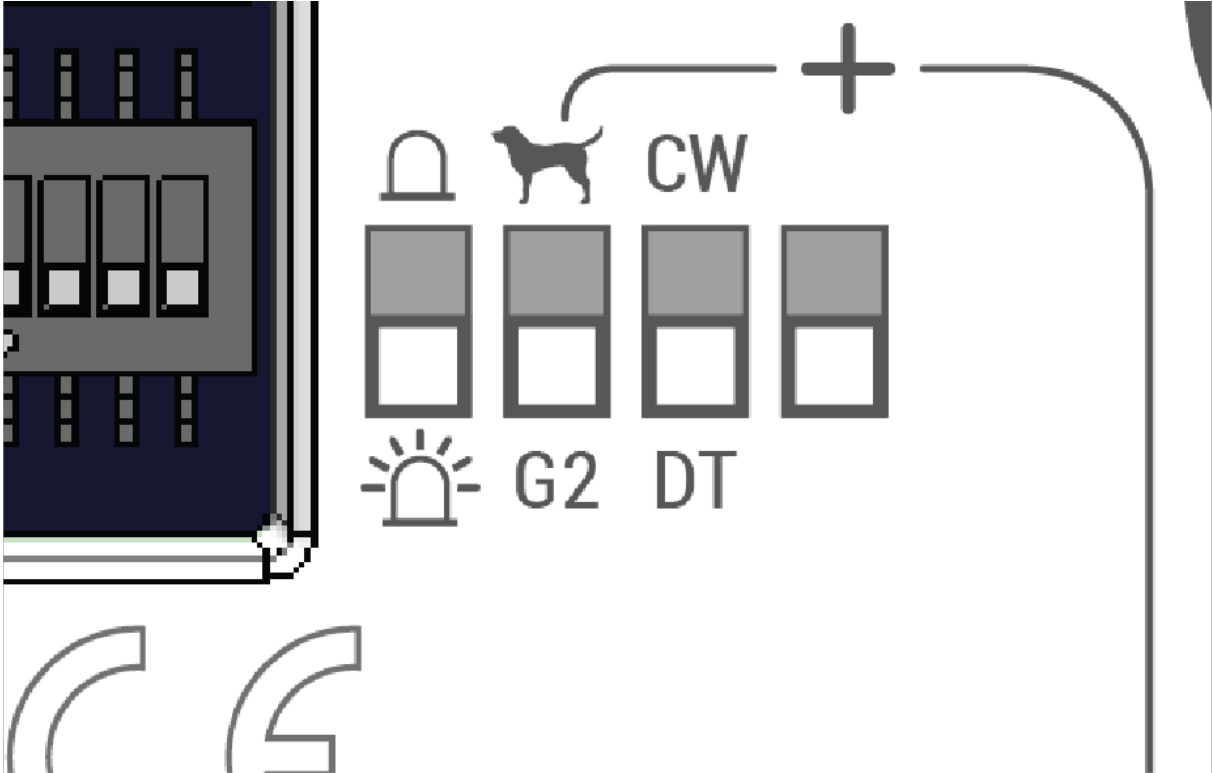

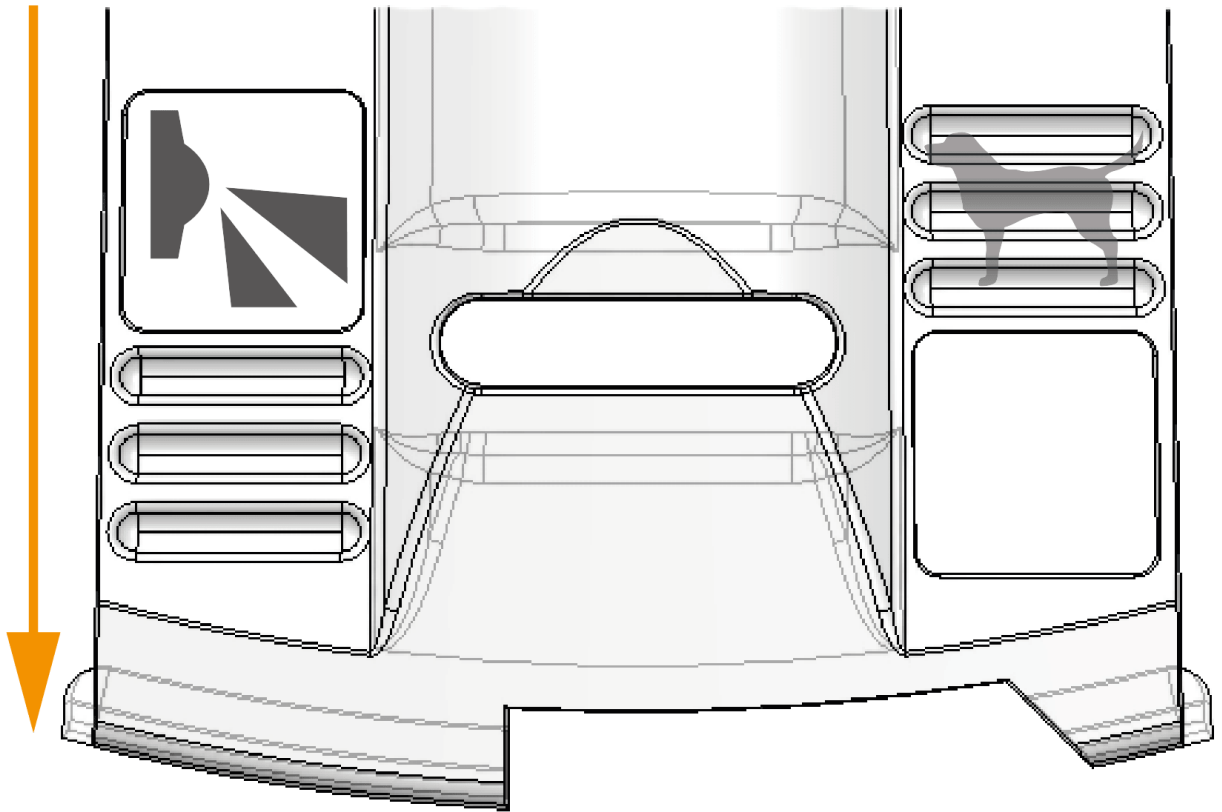

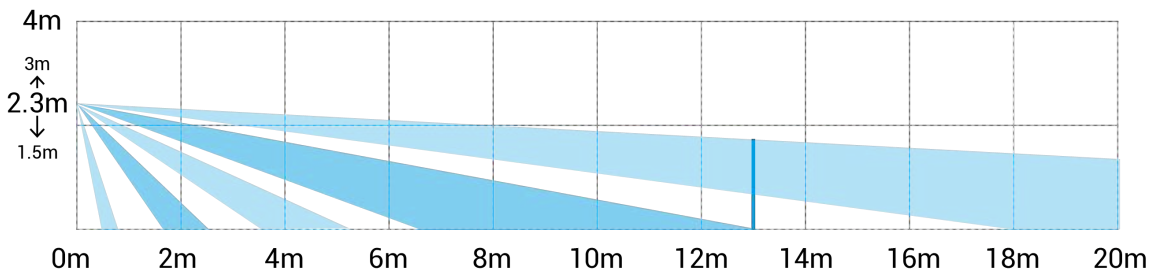
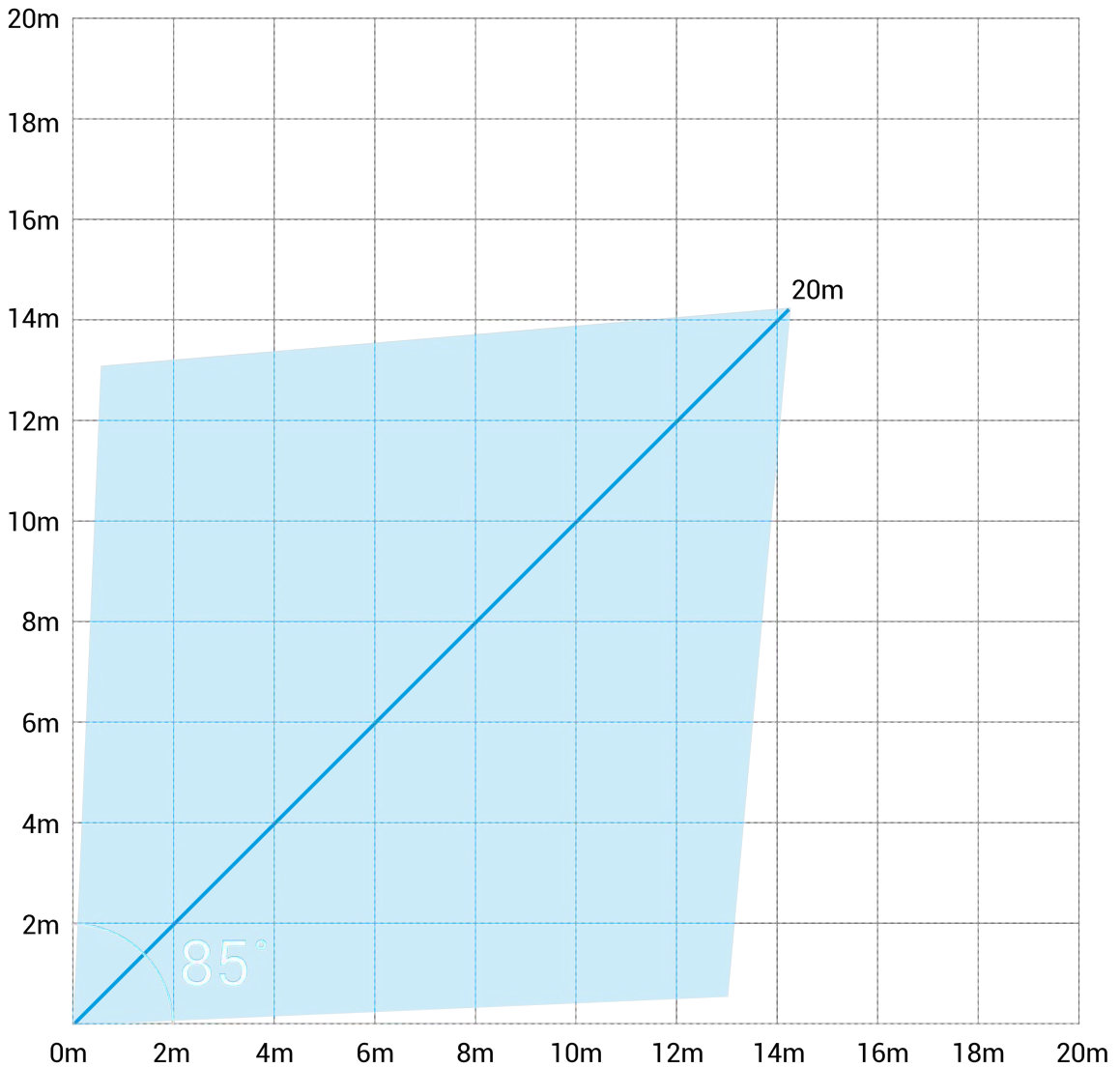

Pet coverage

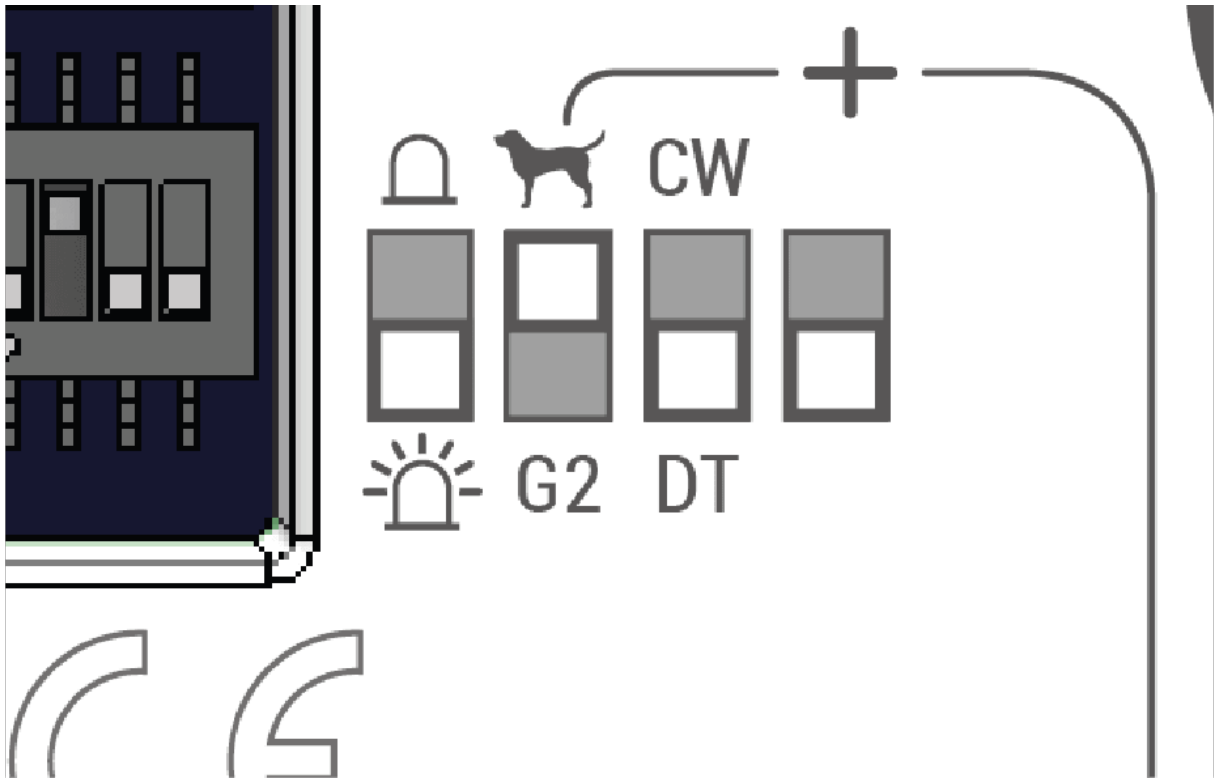

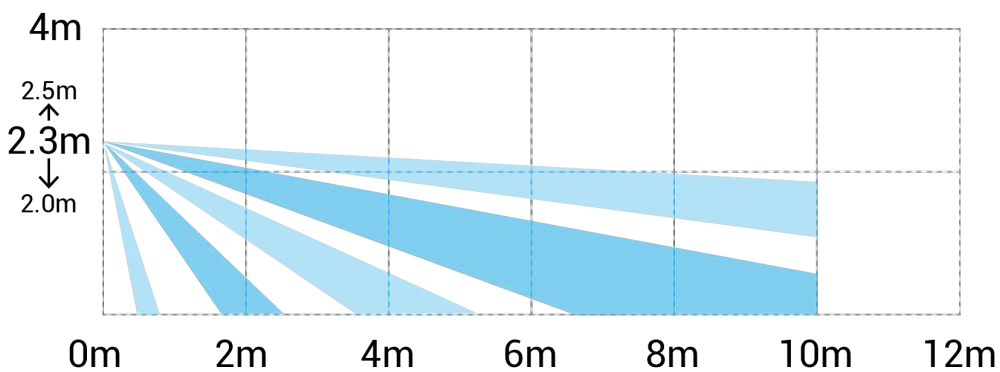
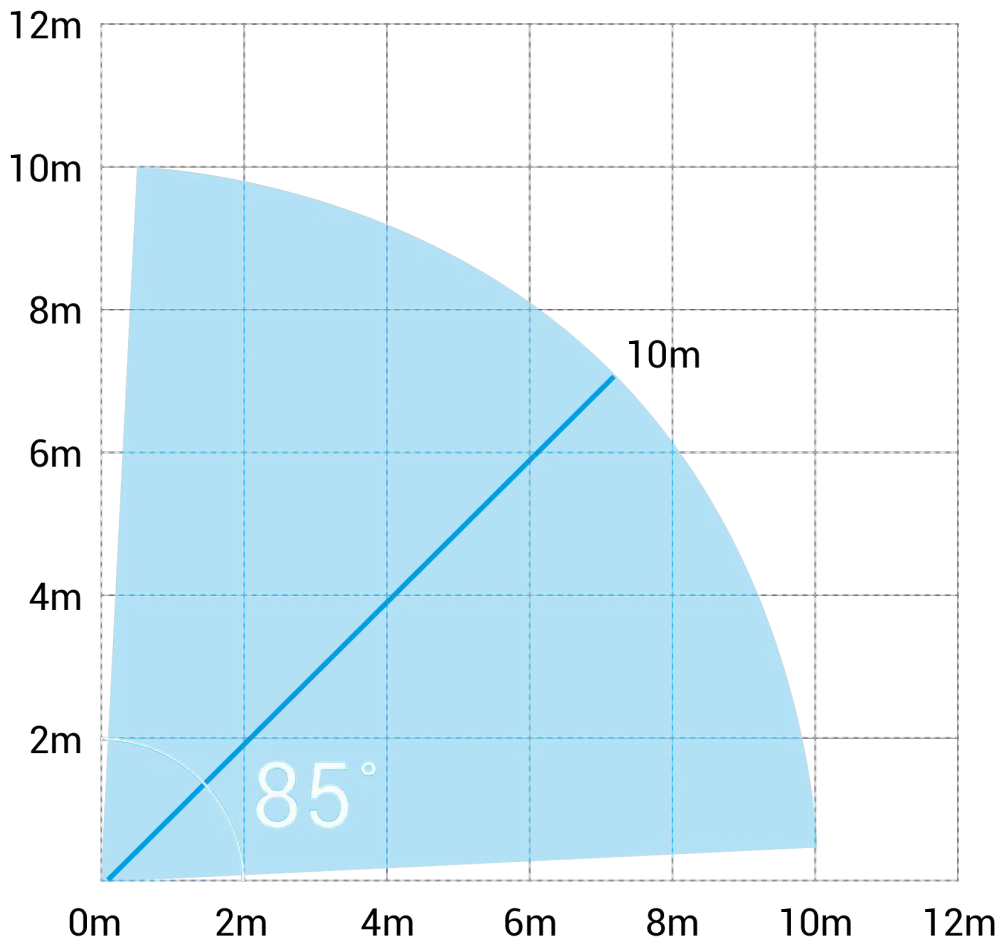

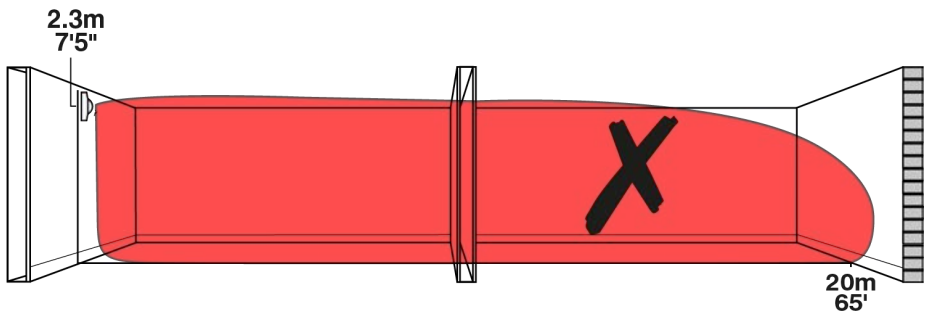
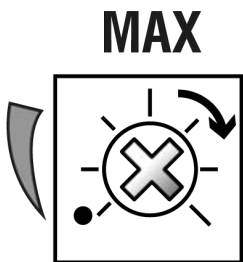
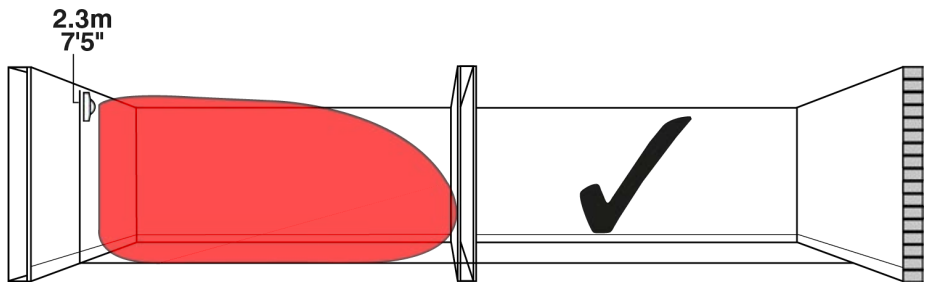
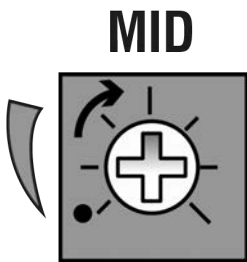
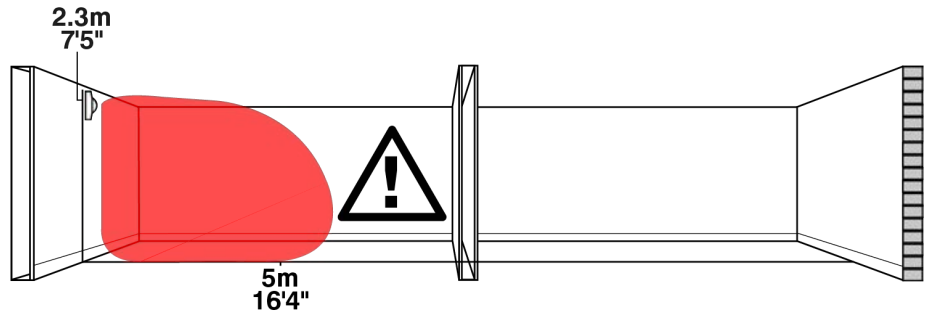
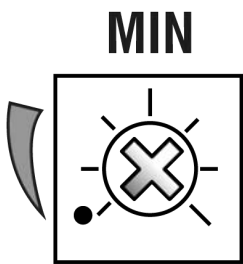
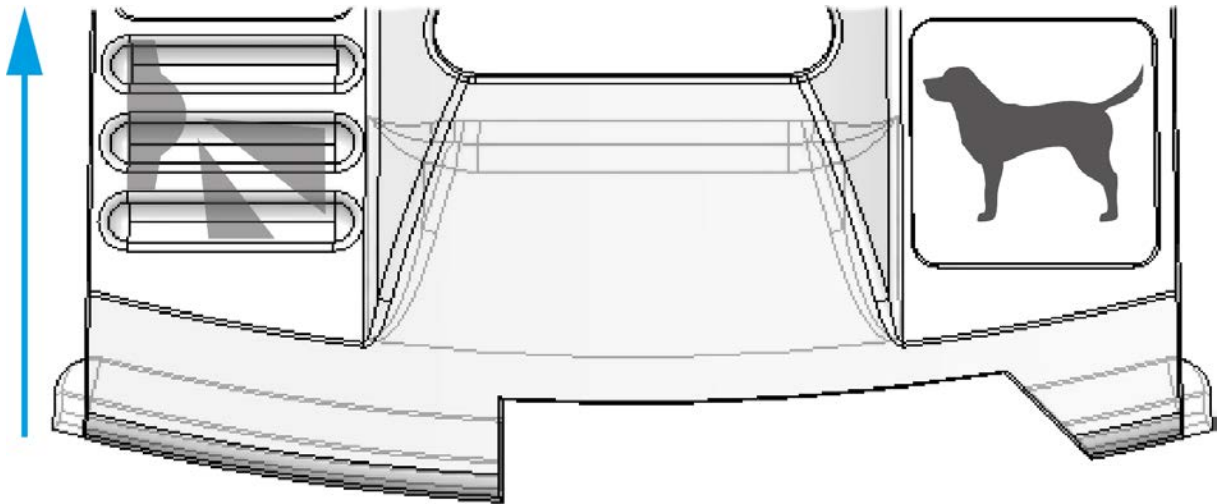

2.4 CAPTURE CQ

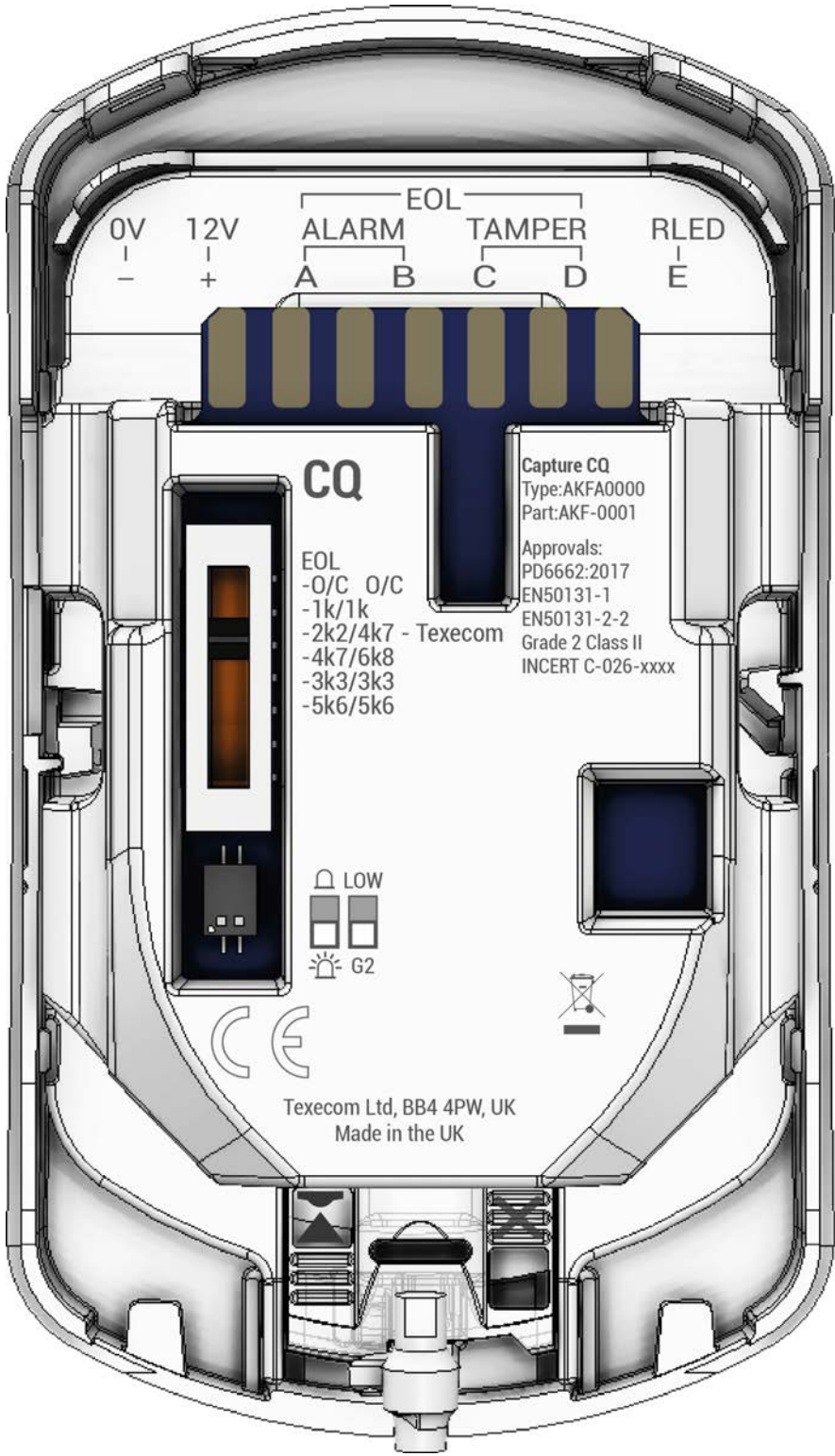

0V | 12V | EOL | RLED
 - | + | ALARM | TAMPER | E
 | | A | B | C | D |

CQ

EOL
 -0/C 0/C
 -1k/1k
 -2k2/4k7 - Texcom
 -4k7/6k8
 -3k3/3k3
 -5k6/5k6

Capture CQ
 Type: AKFA0000
 Part: AKF-0001

Approvals:
 PD6662:2017
 EN50131-1
 EN50131-2-2
 Grade 2 Class II
 INCERT C-026-xxxx

LOW
 G2

Texcom Ltd, BB4 4PW, UK
 Made in the UK

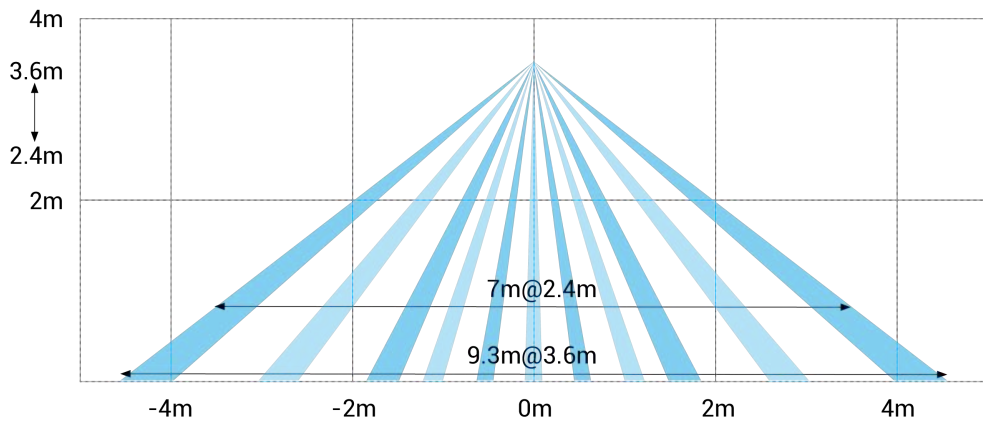
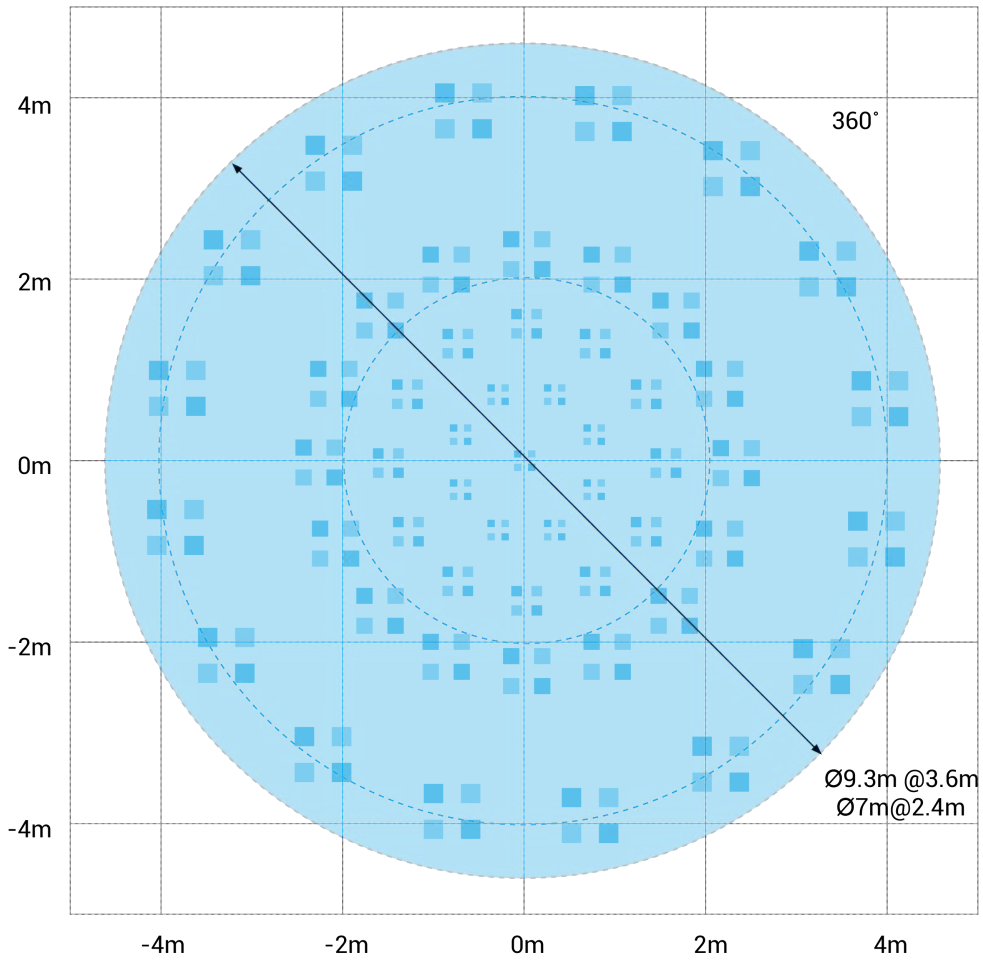

DO NOT USE

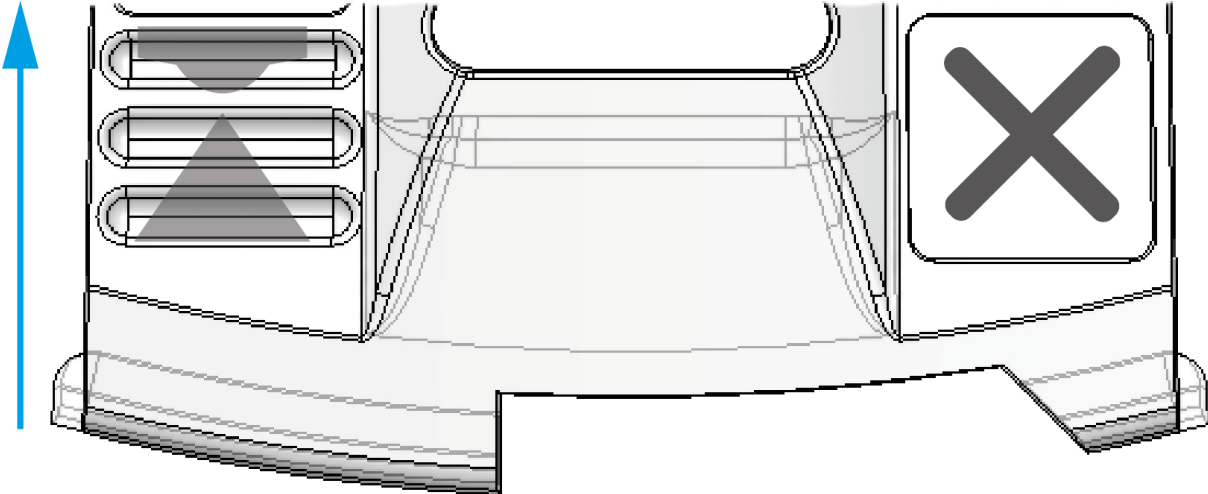

2.5 CAPTURE CD

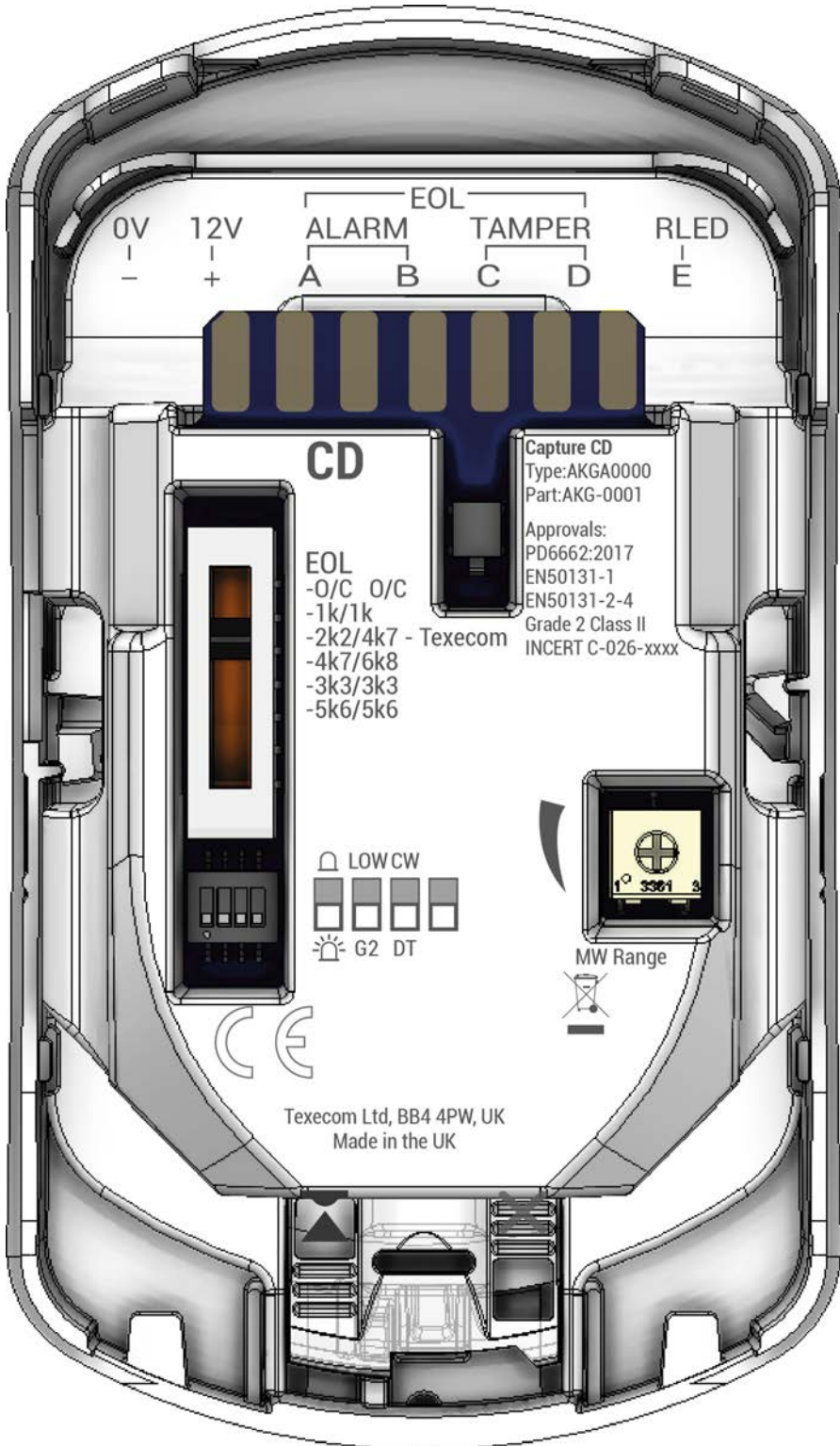

PIR

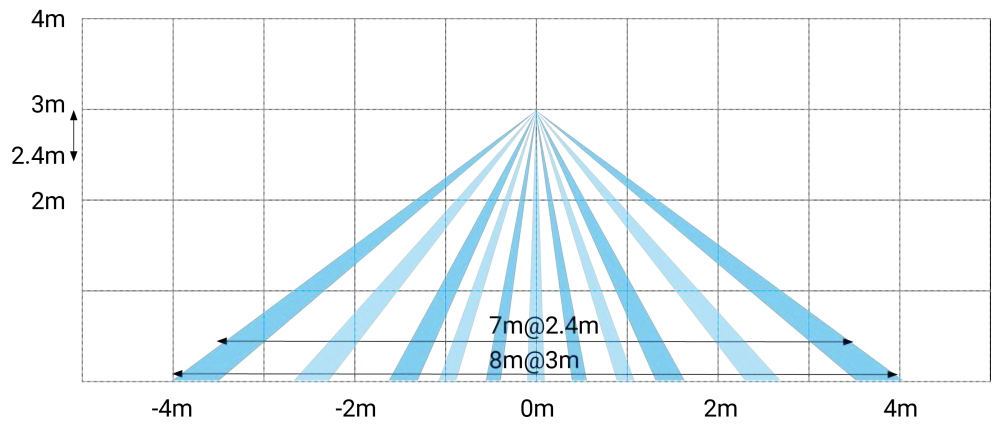
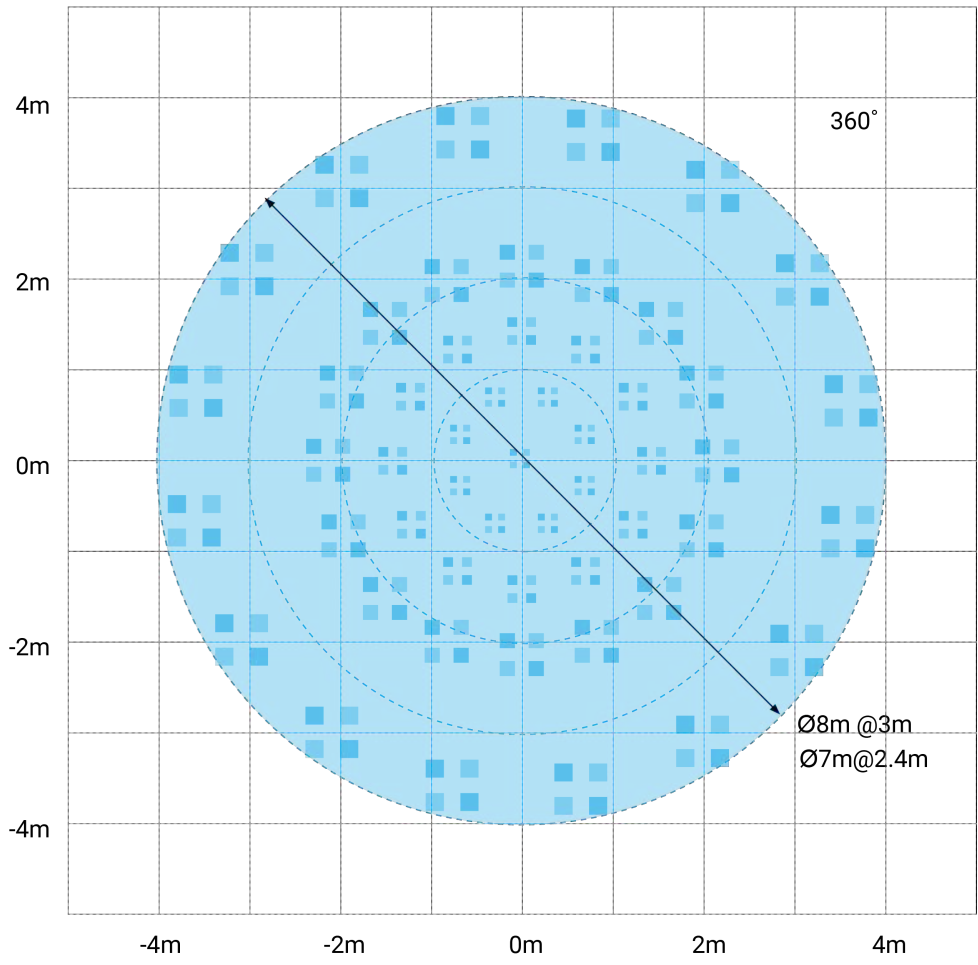

Microwave

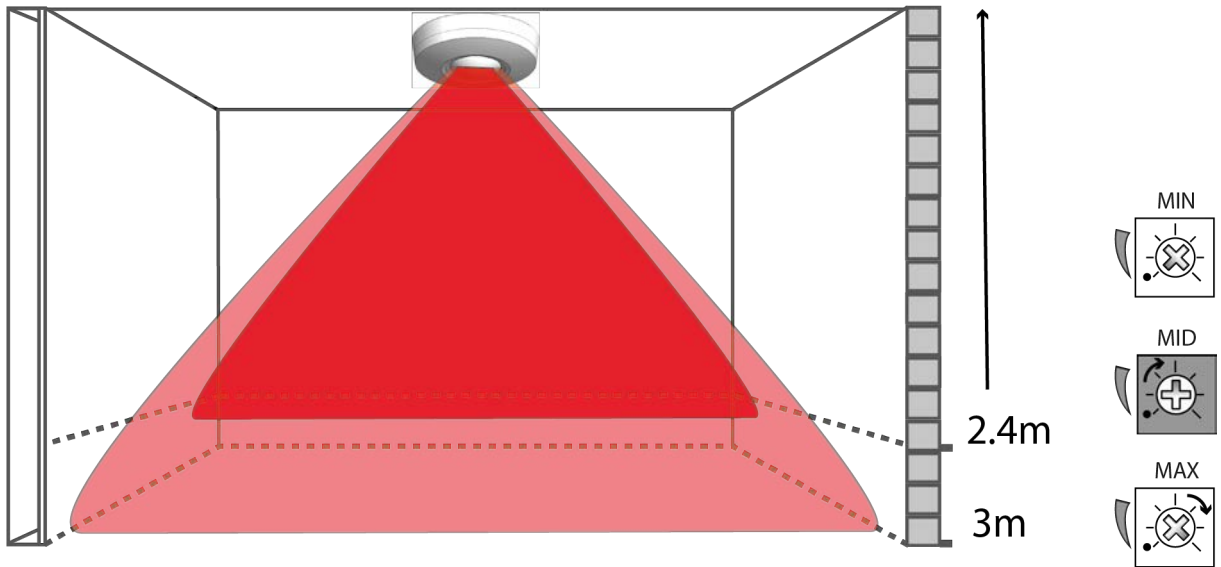

DO NOT USE

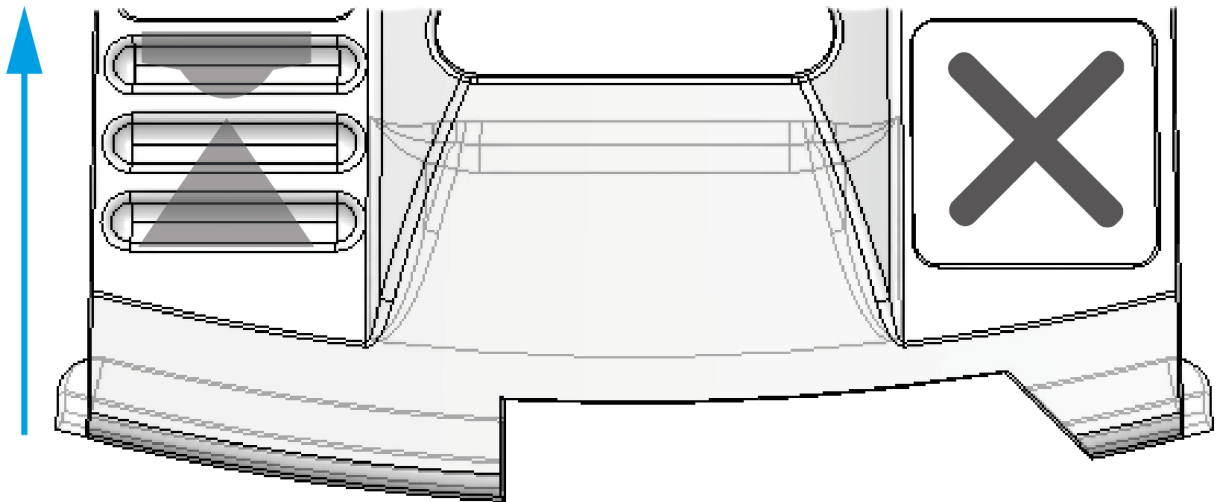

3.0 Accessories

3.1 Branding

Branding is available for wall mount devices from our website [CLICK HERE](#) and consists of a printed insert and a clear cover which fits over the front of the device and holds the insert in place.

Note: The cover should be removed before sliding the front of the device off for servicing or adjustment.







*Bespoke branding.
Captured.*



ABC ALARMS

3.2 Optional wall or ceiling mount brackets

Part Numbers

Pack of 10 brackets AFU-0004

Screws & Fixings

To ensure maximum stability 2 screws should be used for either mounting option.

Dependent on the mounting substrate, suitable fixings may be required. The size and type will depend on the choice of fixing screw.

Ceiling mount

- No.6-No.8 CSK 15-25mm

Wall mount

- No.6 Pan head 15-25mm

Ceiling mount installation

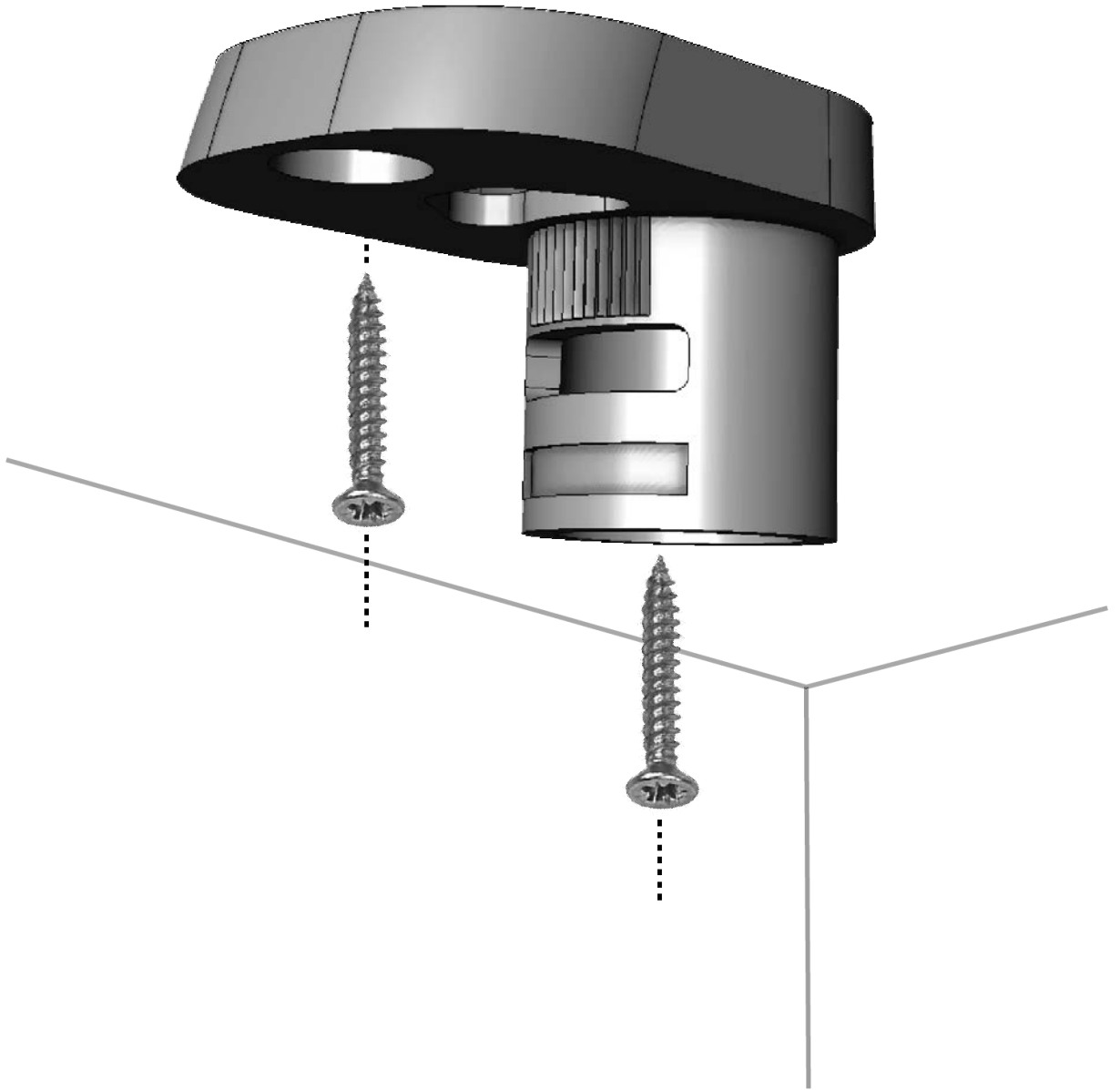

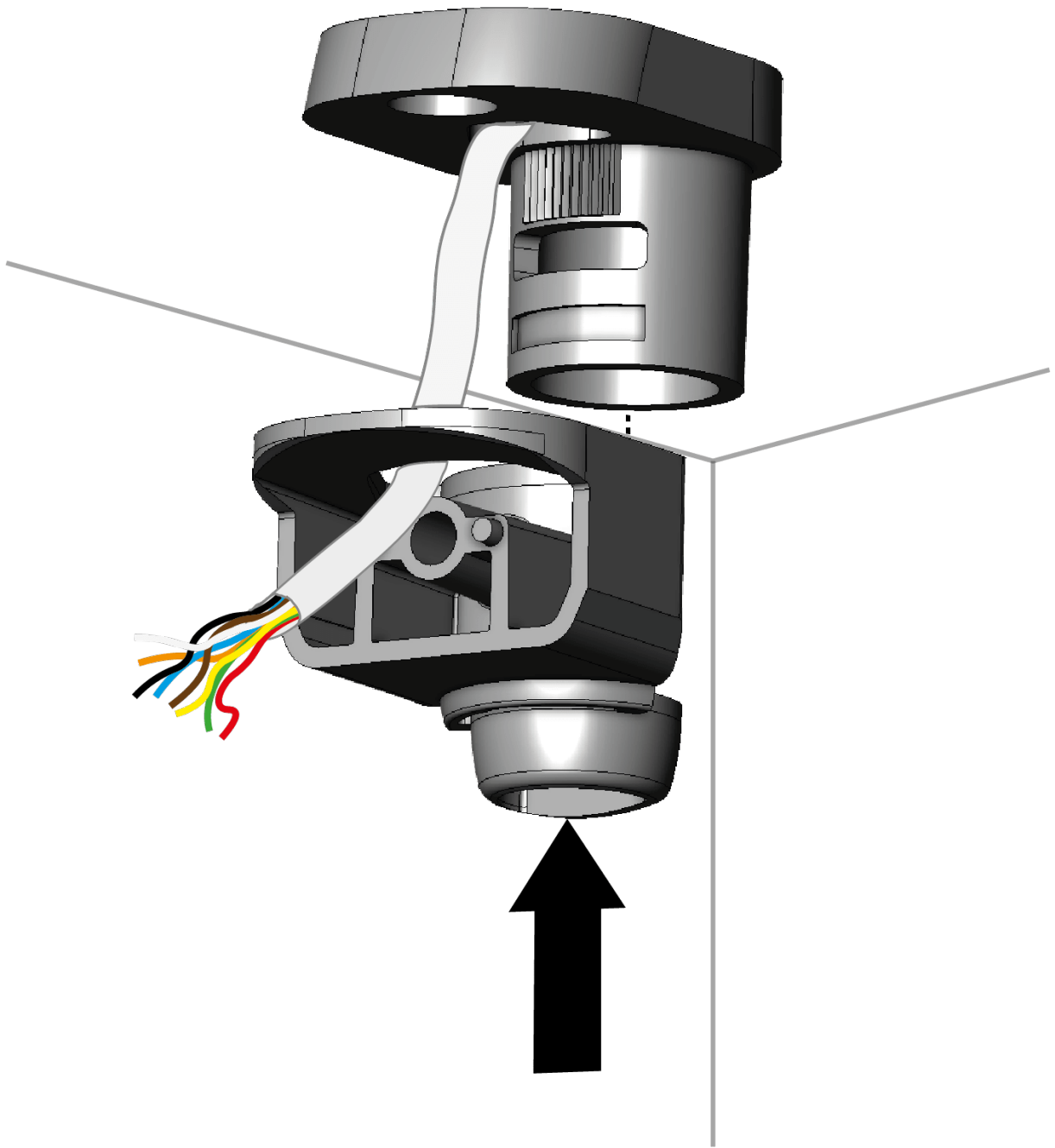

Wall mount installation

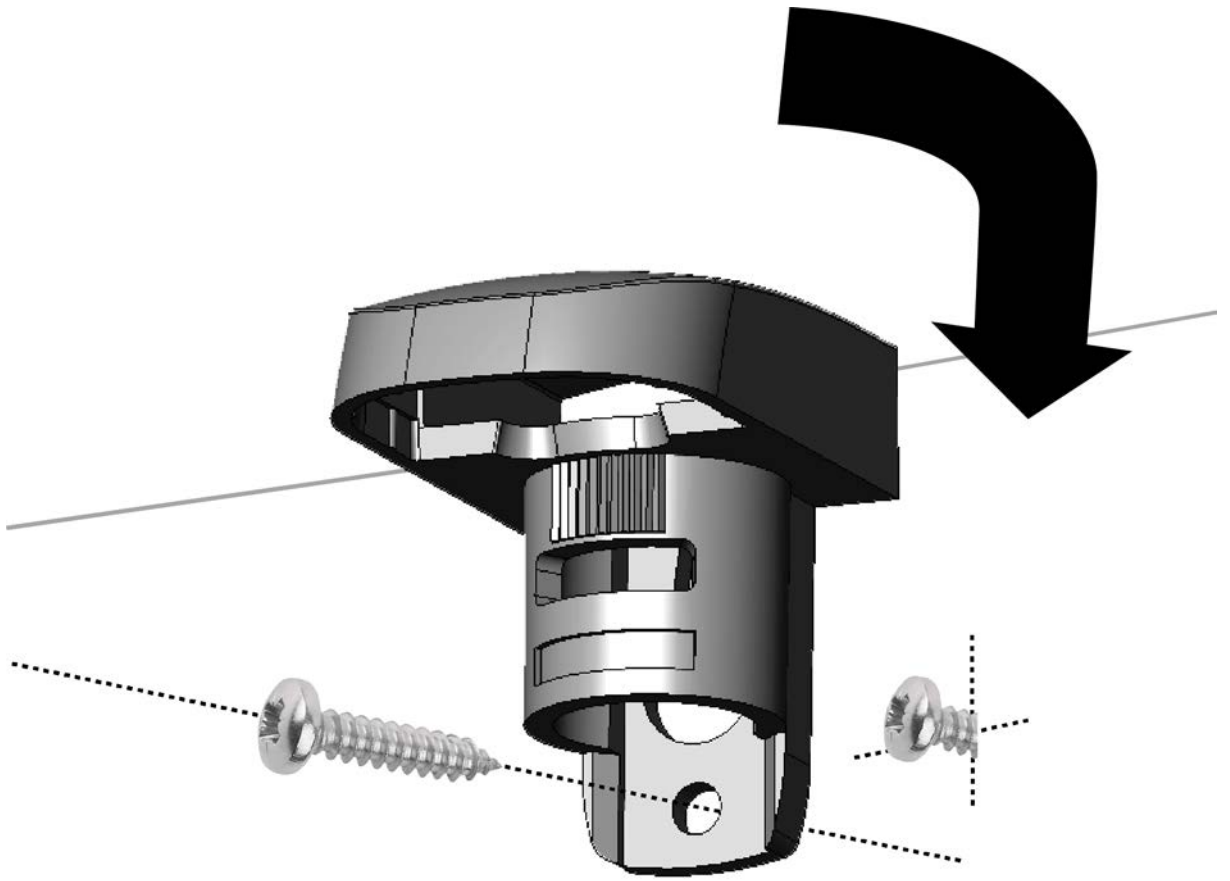

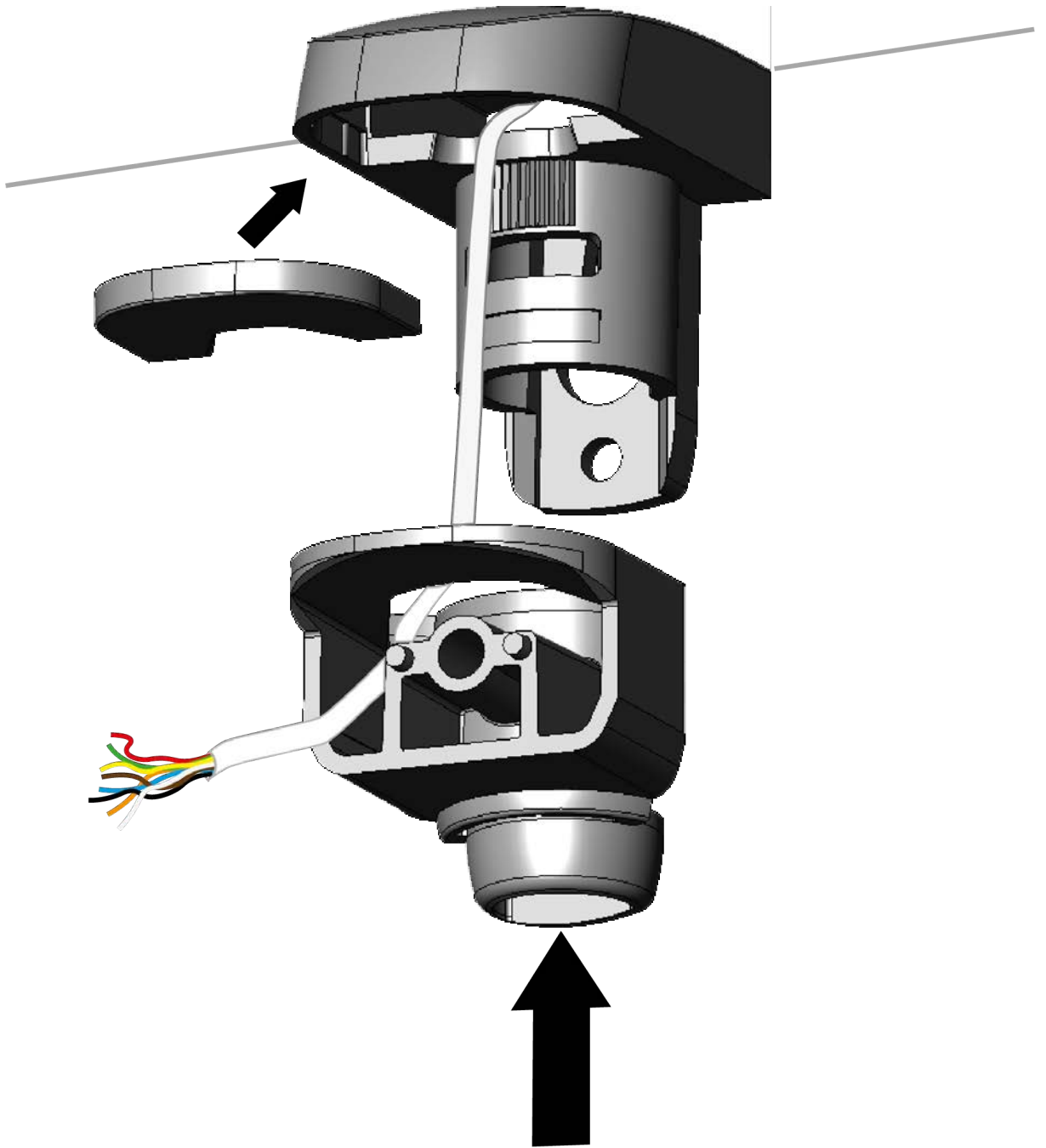

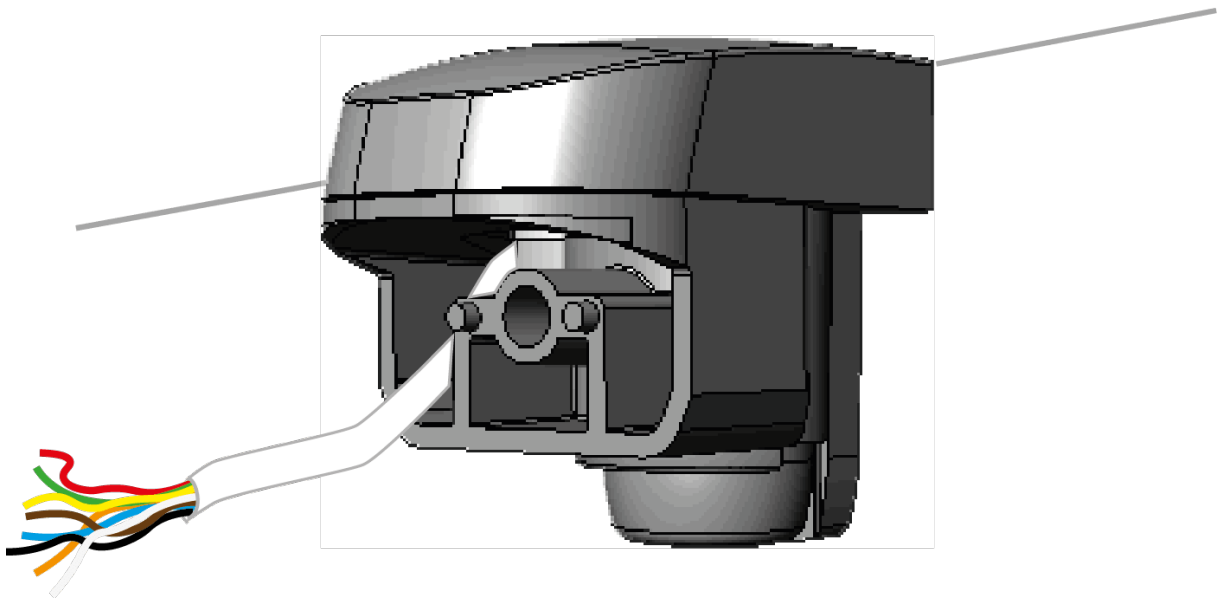

4.0 Specifications

Specifications	P15, Q20, D20, CQ, CD
Alarm System	EN50131-2-2 (P15, Q20, CQ) EN50131-2-4 (D20, CD), EN50131-1, PD6662:2017 Grade 2 Class II
Product Type	AKBA0000 (P15) AKCA0000 (Q20) AKDA0000 (D20) AKFA0000 (CQ) AKGA0000 (CD)
Operating Voltage	9-15Vdc (12V + - 25%)
Maximum Current (measured at 12V)	P15, Q20, CQ - 12mA D20 - 13mA CD - 17mA

Specifications	P15, Q20, D20, CQ, CD
Quiescent Current (measured at 12V)	P15, Q20, CQ - 9.3mA D20 - 11.5mA CD - 15.5mA
Relative Humidity	0-95% non-condensing
Operating Temperature	-10°C to 55°
Weight	P15, Q20, CQ (no ring or fascia) - 106g P15, Q20 (with fascia and insert) - 124g CQ (with ring) - 163g D20, CD (no ring or fascia) - 110g D20 (with fascia and insert) - 128g CD (with ring) - 167g
Dimensions	Wall Mount: Width 65mm, Height 112mm, Depth 43mm. Ceiling Mount: 125mm Diameter, Depth 43mm.

5.0 Legal information

5.1 Supplier

Texecom Ltd, Haslingden, Lancashire, BB4 4PW, UK. Made in England

5.2 WEEE Directive

2012/19/EU (WEEE Directive): Products marked with this symbol cannot be disposed of as unsorted municipal waste in the European Union. To recycle, return this product to your local supplier upon the purchase of equivalent new equipment, or dispose of it at designated collection points. For more information see: www.recyclethis.info.

5.3 Maintenance

Test yearly by the installer

5.4 Warranty

Limited lifetime warranty. As the Capture P15, Q20, D20, CQ, CD is not a complete alarm system, but only a part thereof, Texecom cannot accept responsibility or liability for any damages whatsoever based on a claim that the Capture P15, Q20, D20, CQ, CD failed to function correctly. Due to our policy of continuous improvement Texecom reserves the right to change specification without prior notice. Texecom provides a **10 year warranty** to end user customers who purchase new products in its Capture range (**Products**). Further details of this 10 year warranty are set out here https://www.texe.com/uk/uploads/Capture_Lifetime_Warranty_20201023.pdf A current list of products can be found here: <https://www.capture.texe.com/select>

Hereby, Texecom declares that the equipment type: AKBA0000 (P15) AKCA0000 (Q20) AKDA0000 (D20) AKFA0000 (CQ) AKAG0000 (CD), are in compliance with the Electro-magnetic Compatibility (EMC) Directive 2014/30/EU. The full EU declaration of conformity is available here: <https://www.texe.com/cert/doc/>

Certified by KIWA (Telefication) B.V.

